



1:100 Scale

SN-11



S
T
A
R
S
H
I
P

Designed by Alfonso X Moreno
©2021 Not for commercial use



SpaceX Starship SN 11

Print on Cardstock (110 lbs)

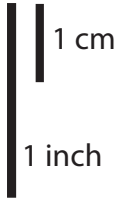

1:100 Scale



ring 7

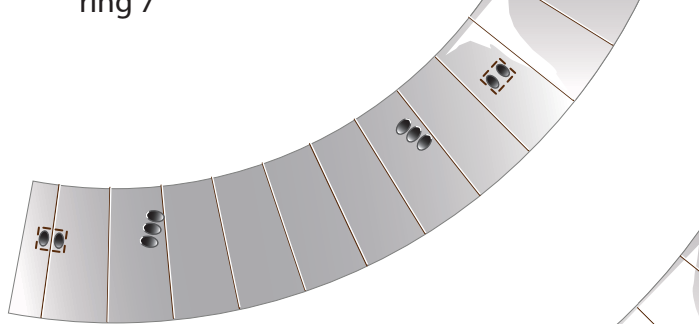

ring 5

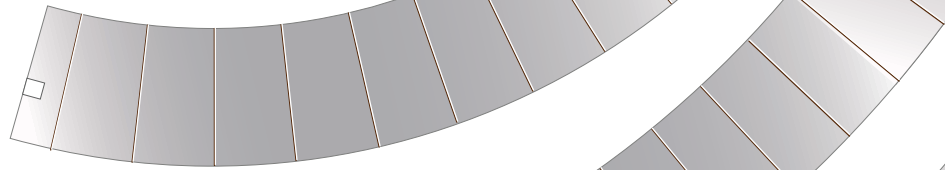

ring 4

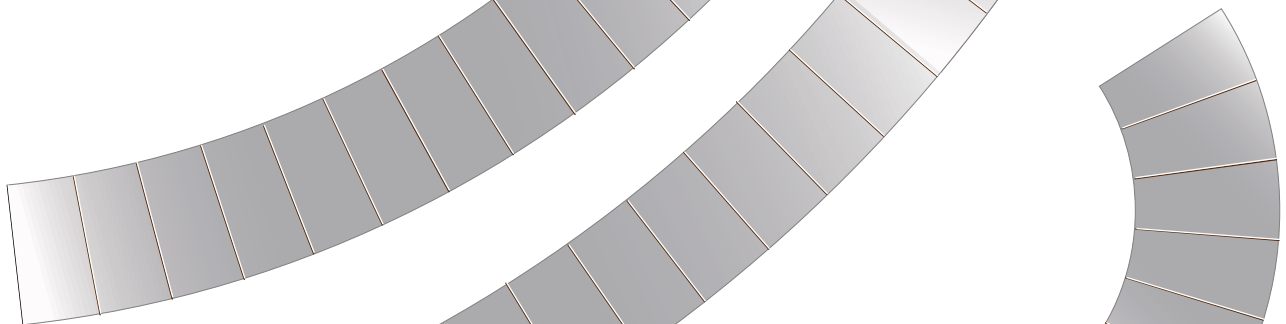

ring 3

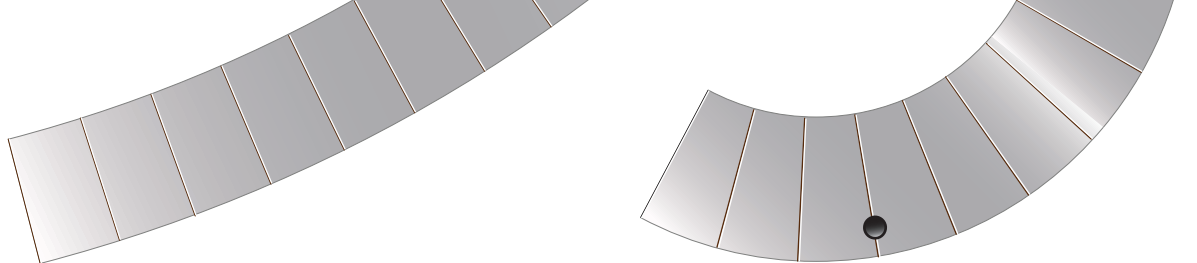

ring 2



ring 9



ring 8

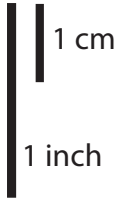

SpaceX Starship SN 11

Print on Cardstock (110 lbs)

1:100 Scale

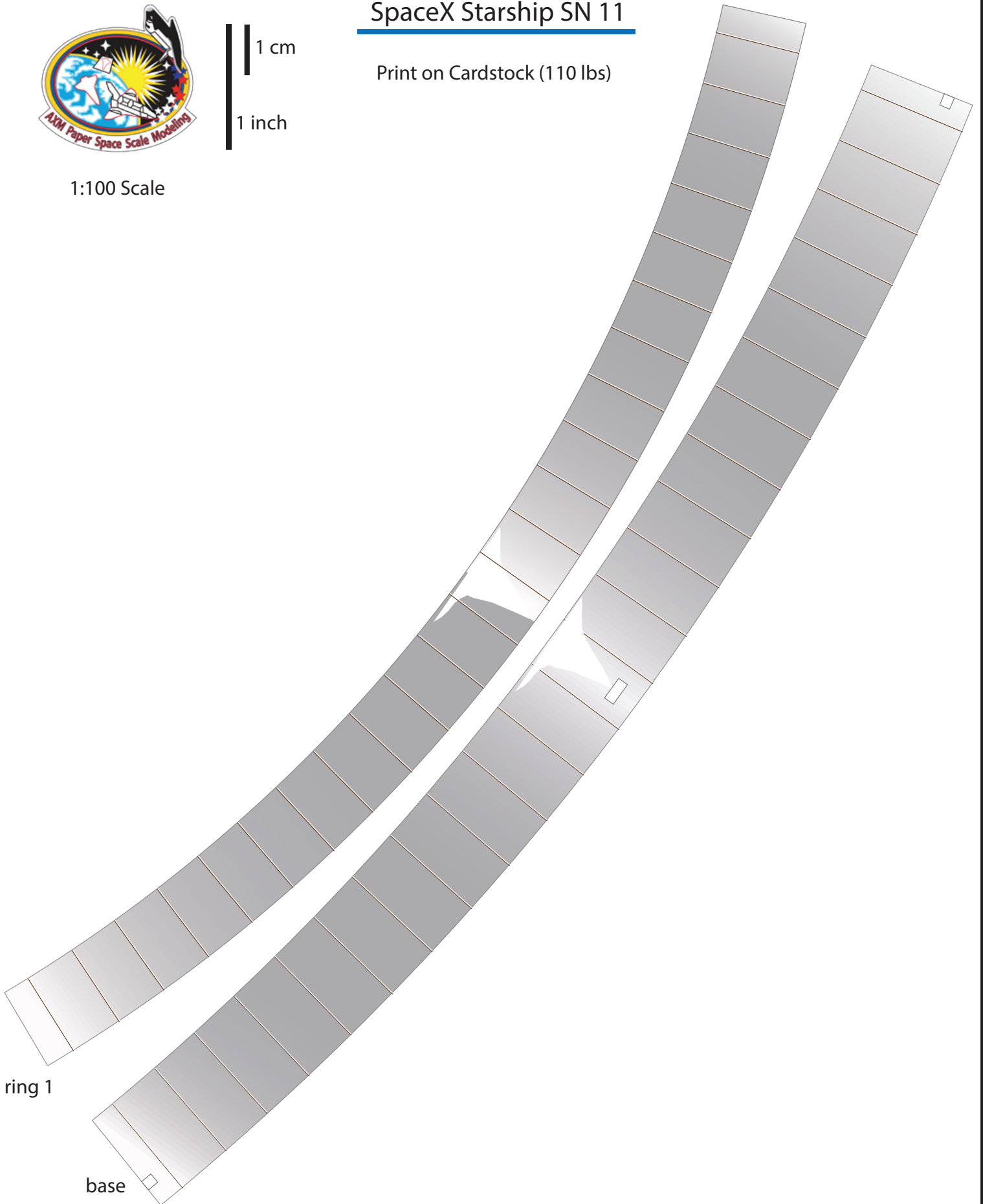



1:100 Scale

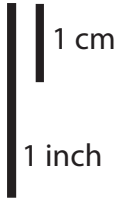

SpaceX Starship SN

Print on Cardstock (110 lbs)

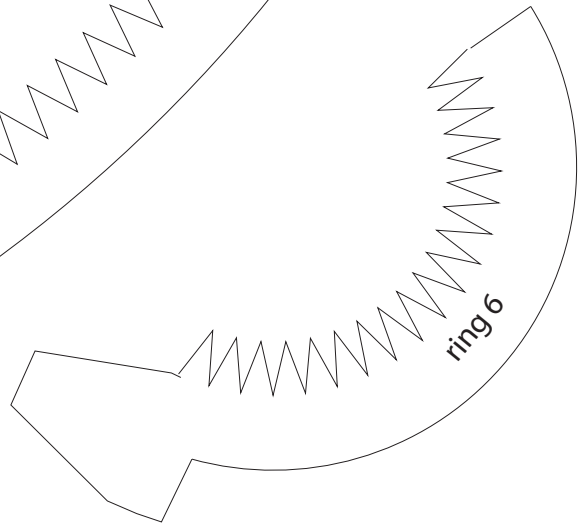
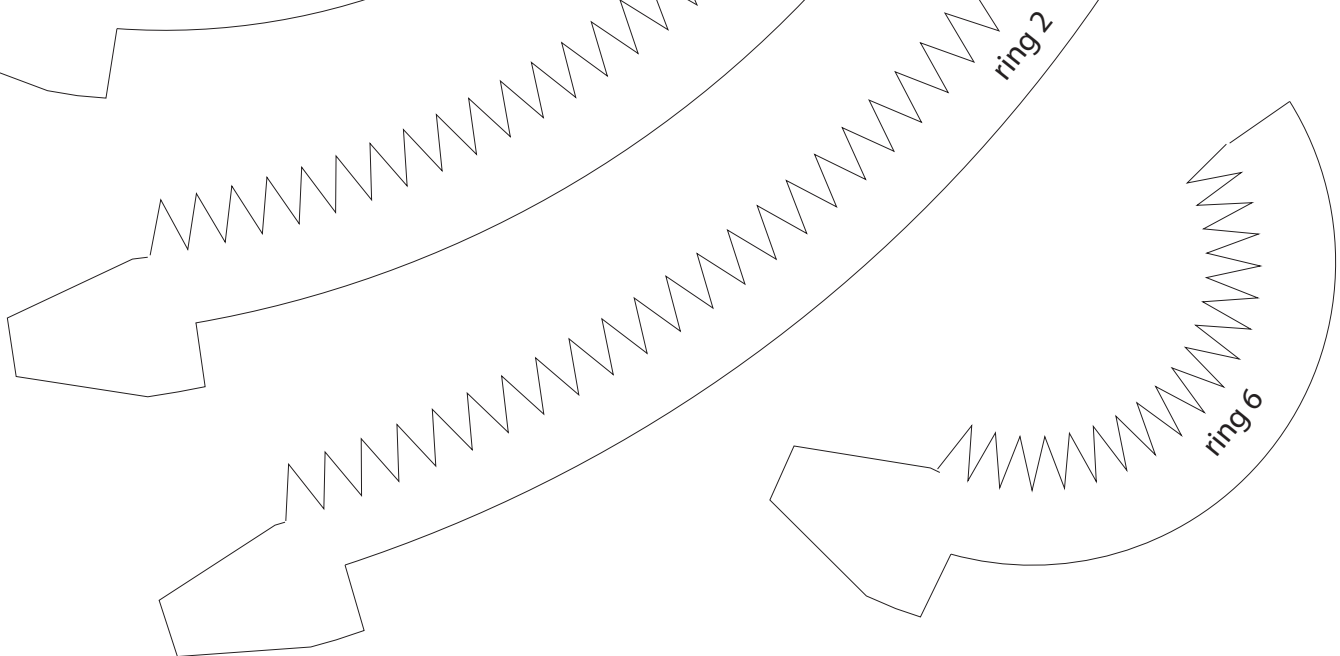
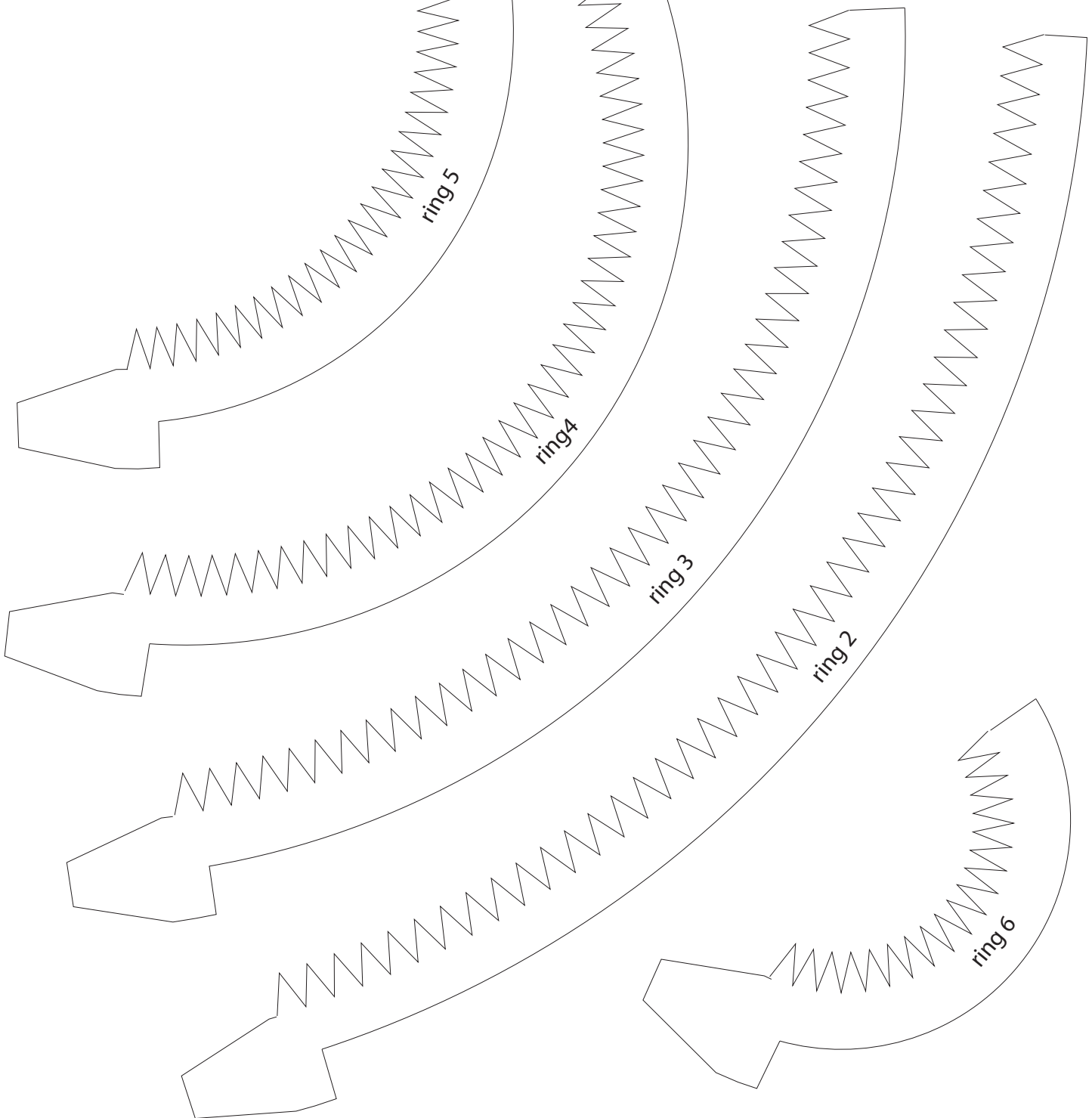
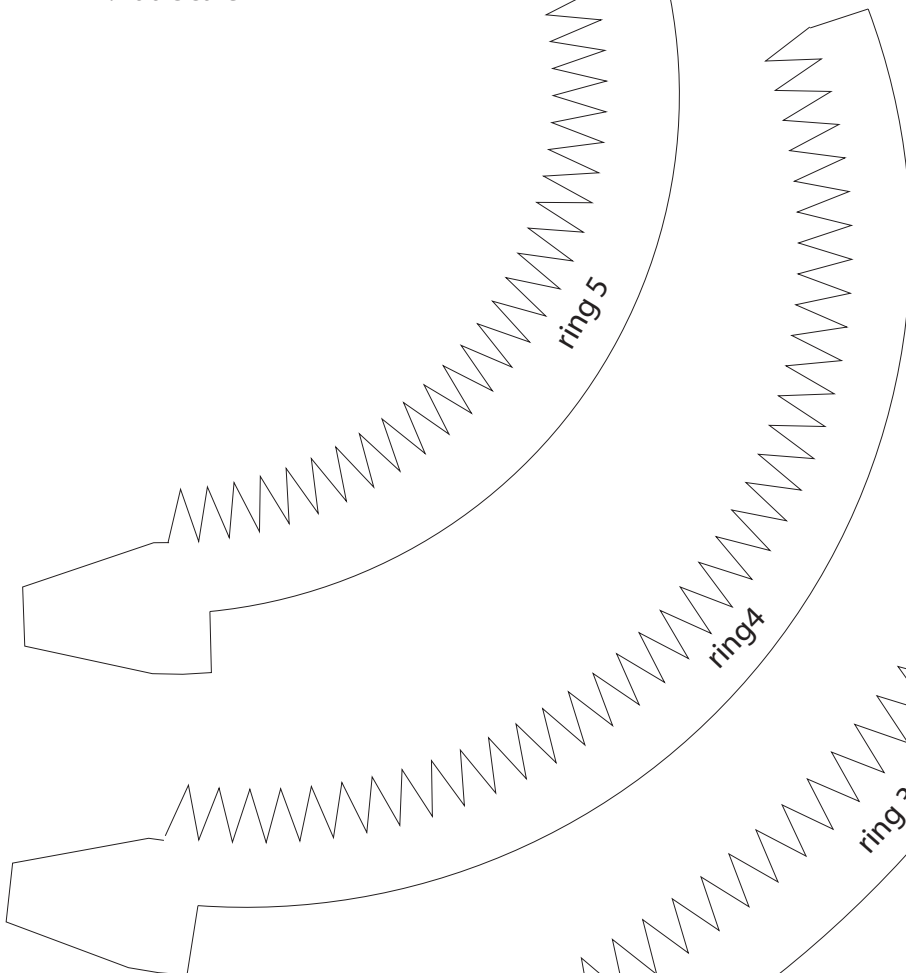
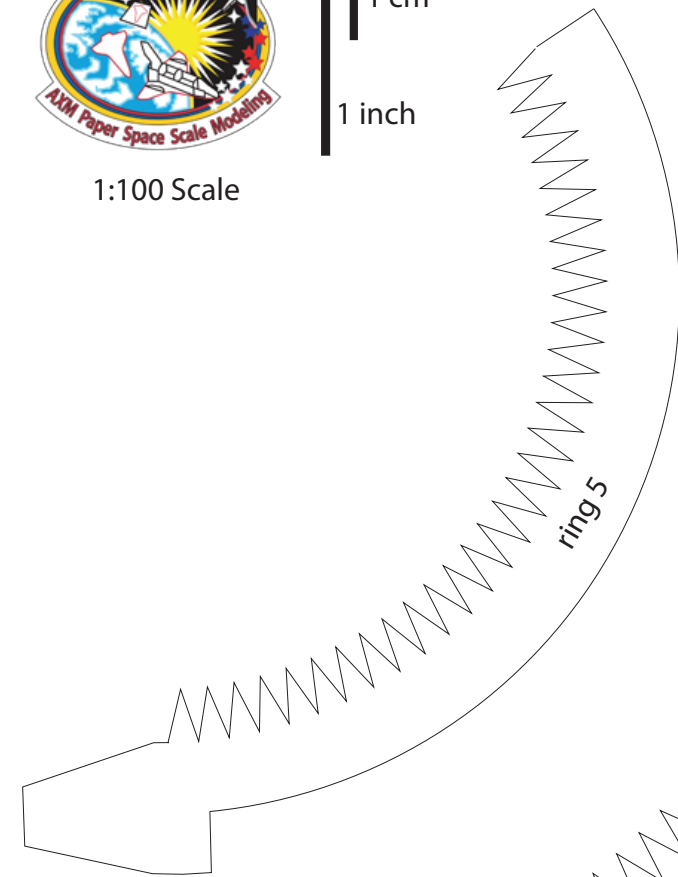
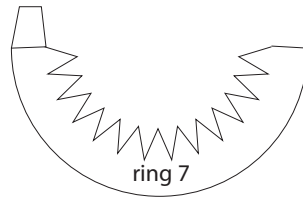



1:100 Scale

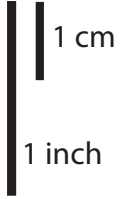

SpaceX Starship SN

Print on Cardstock (110 lbs)

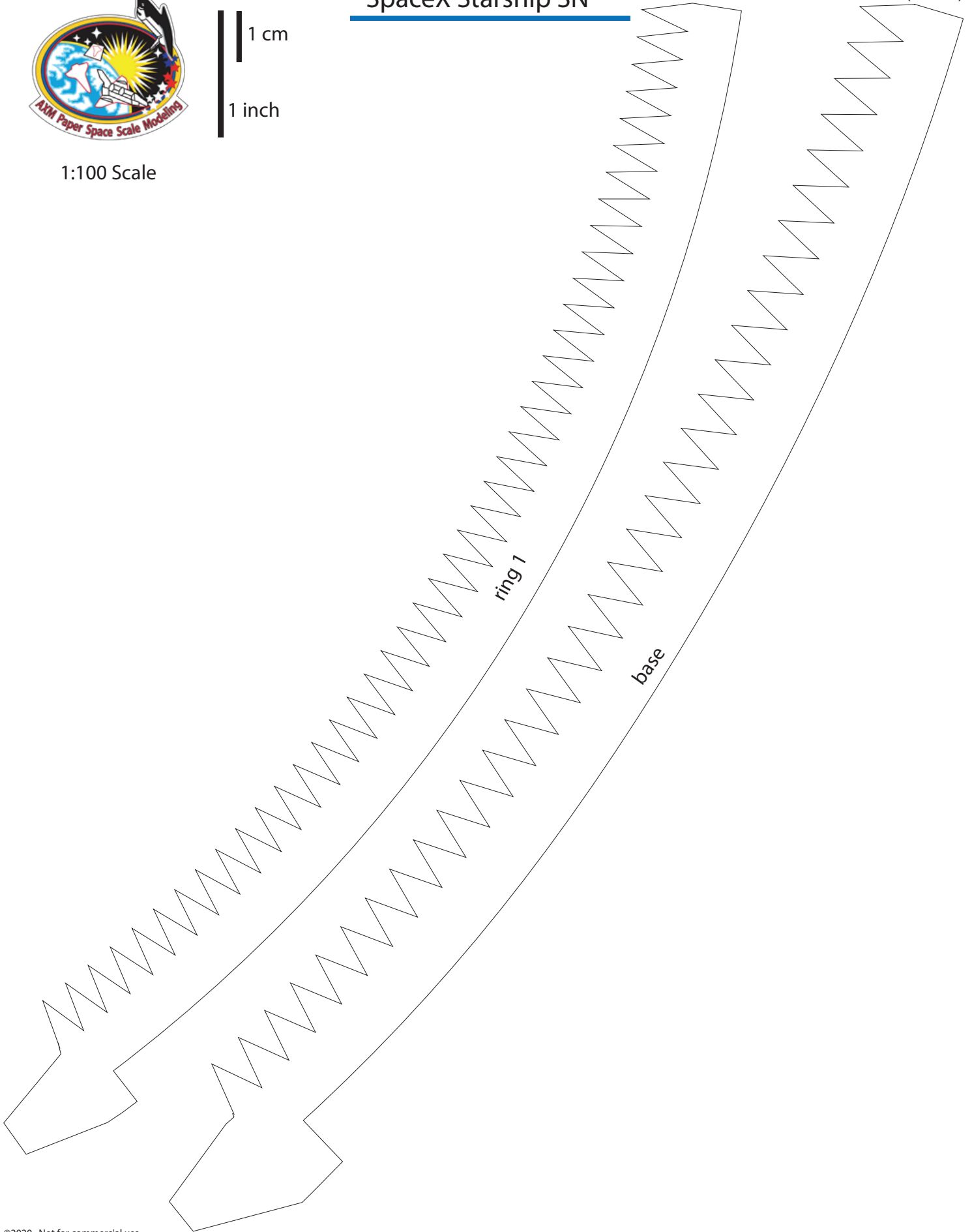



1:100 Scale



SpaceX Starship SN11

Nosecone-body 4 ring stack

Print on Cardstock (110 lbs)

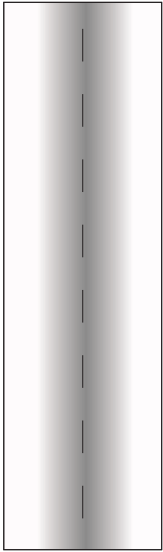

Umbilical side

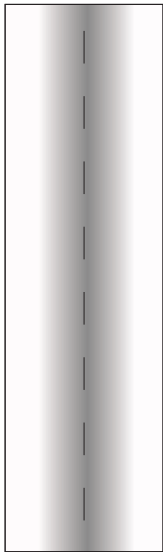
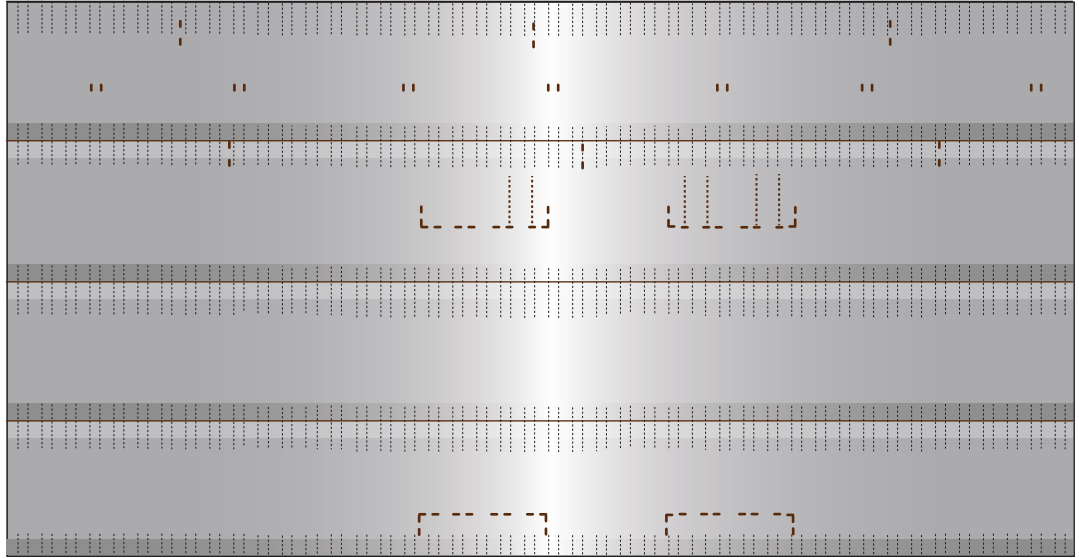

Front

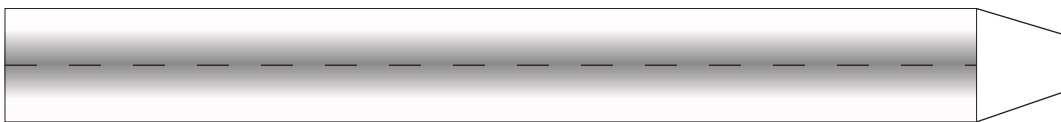
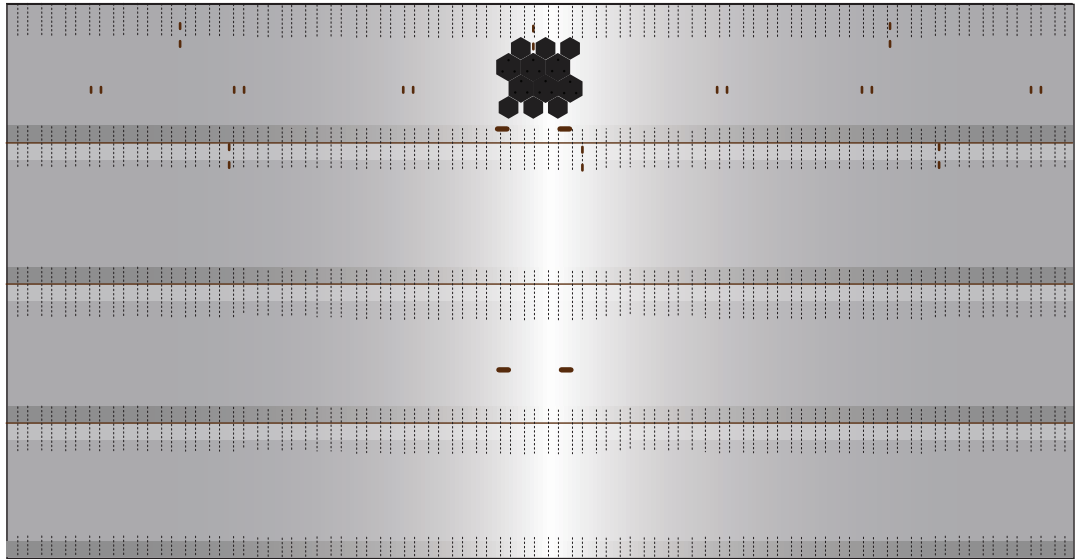

Connectors for 4 ring stack and body





1:100 Scale

1 cm

1 inch

SpaceX Starship SN11

Print on Cardstock (110 lbs)

Belly top

Use only if upper dome is included

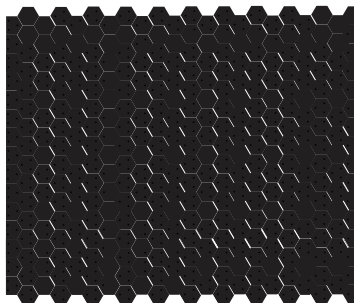
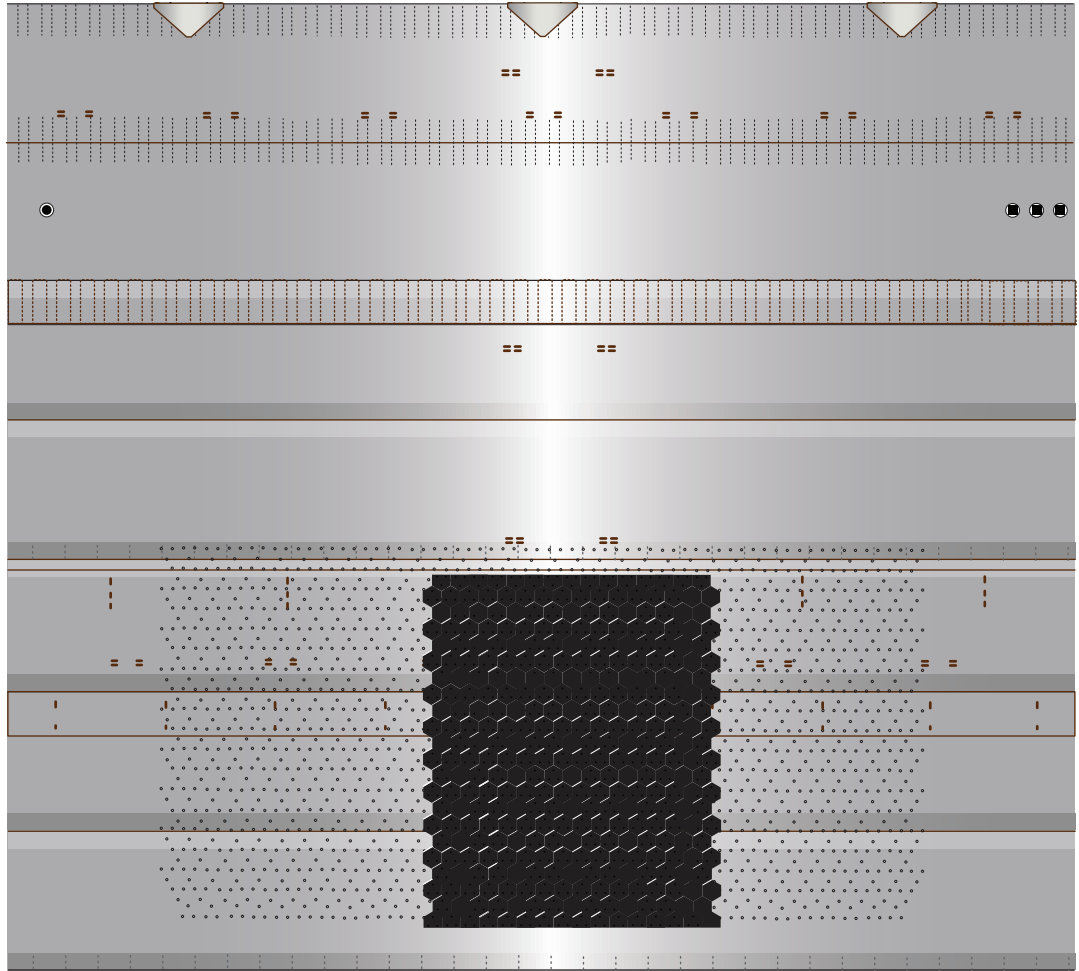
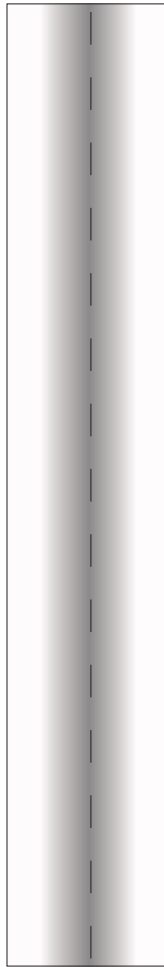
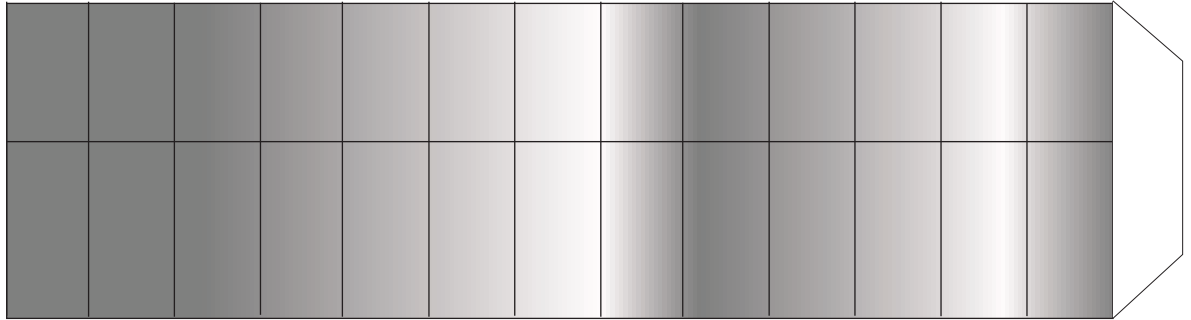



1:100 Scale



SpaceX Starship SN11

Print on Cardstock (110 lbs)

Back top

Use only if upper dome is included

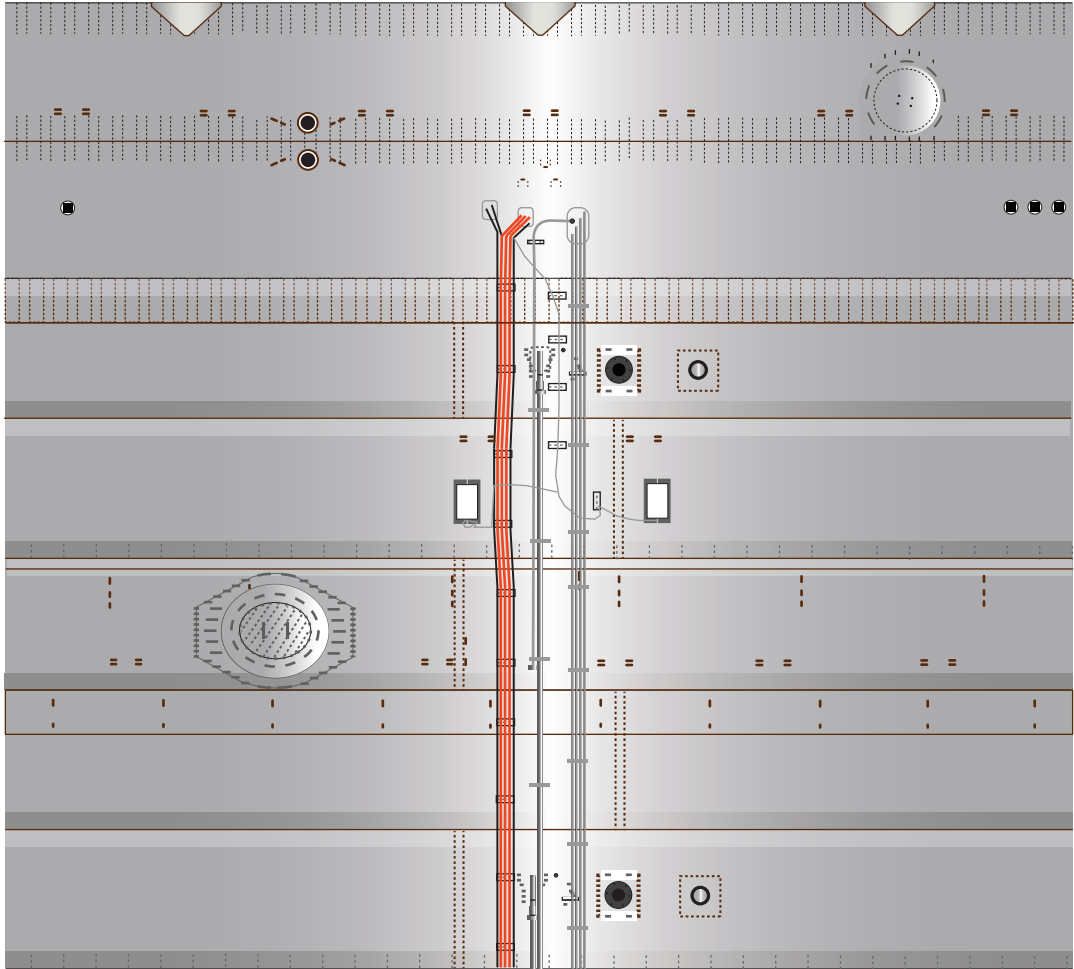
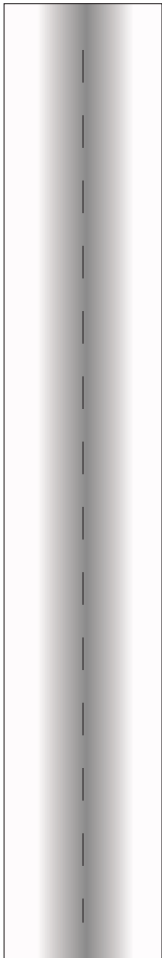
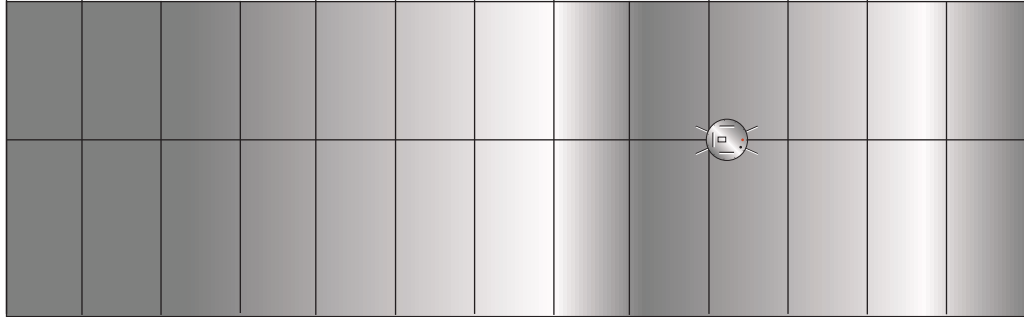



1:100 Scale



SpaceX Starship SN11

Print on Cardstock (110 lbs)

Belly side bottom

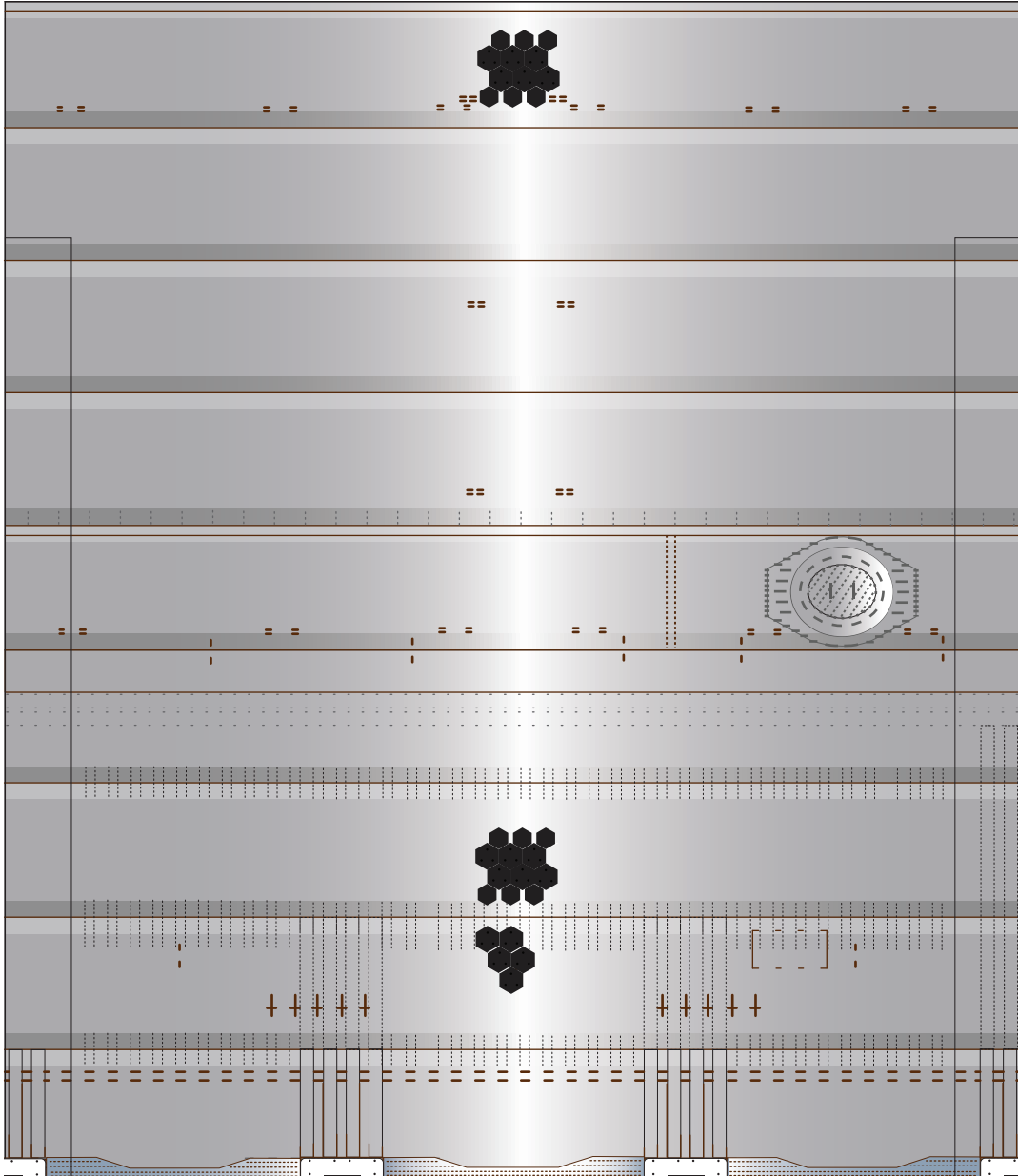
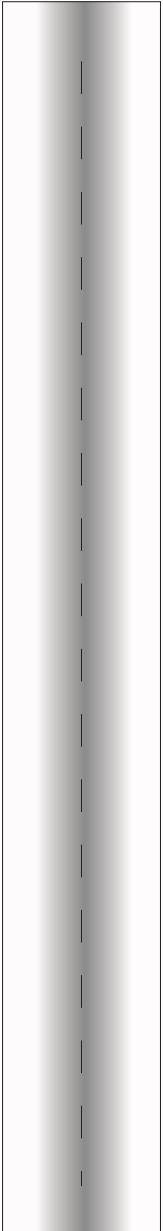



1:100 Scale



SpaceX Starship SN11

Print on Cardstock (110 lbs)

Back bottom

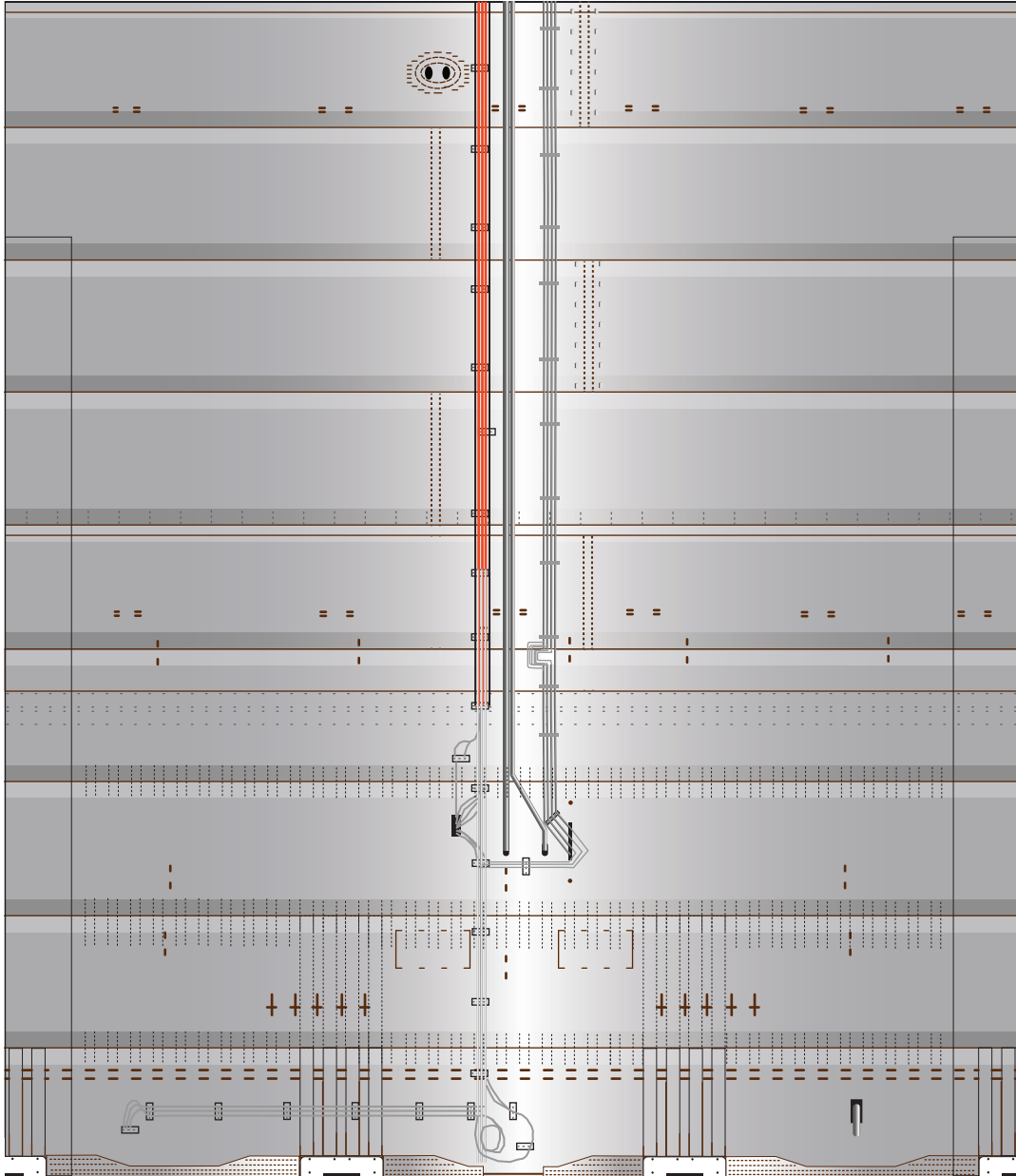
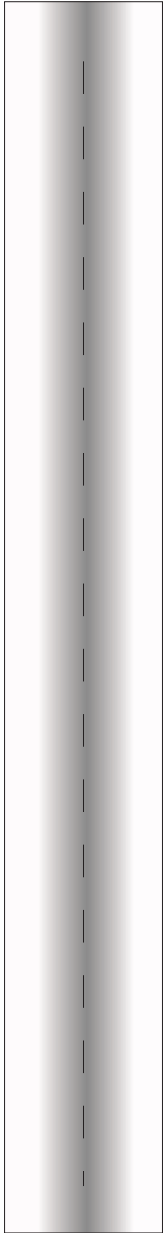



1:100 Scale

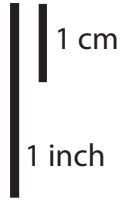

SpaceX Starship SN-11

Print on Cardstock (110 lbs)

Former for upper dome

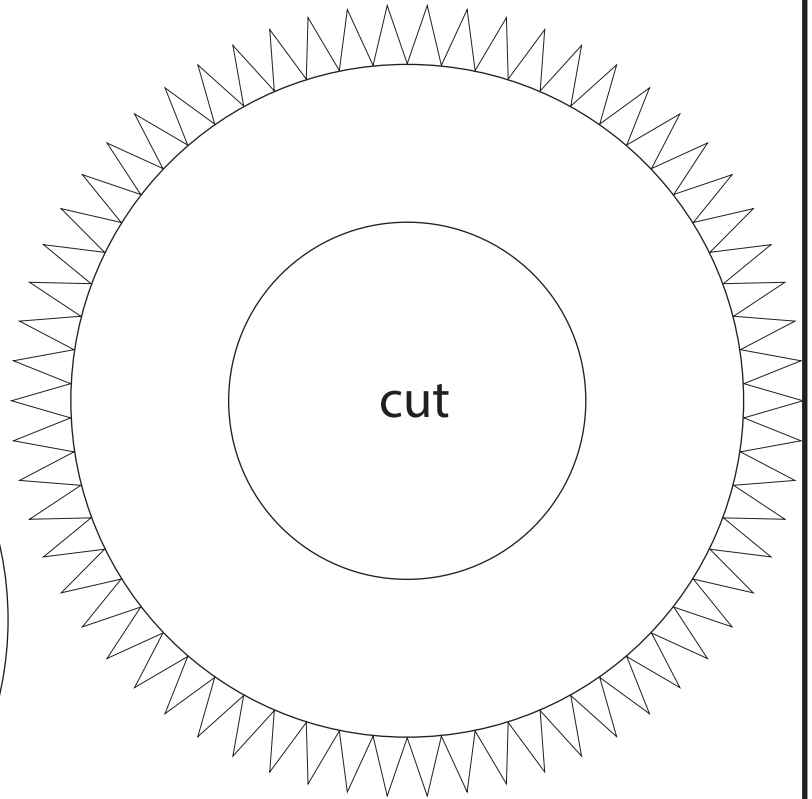
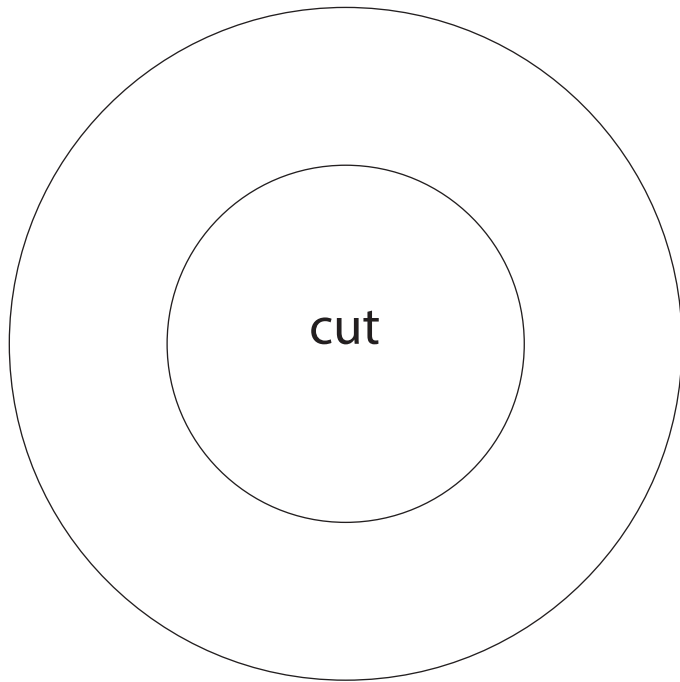

If top dome is not included in model

If top dome is included in model

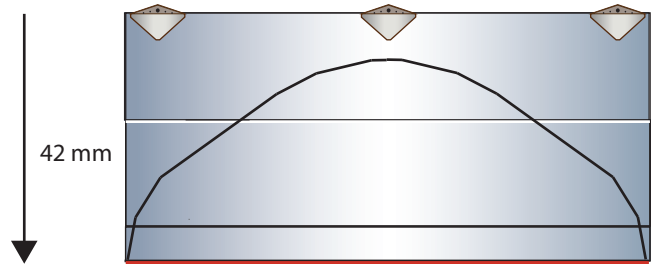
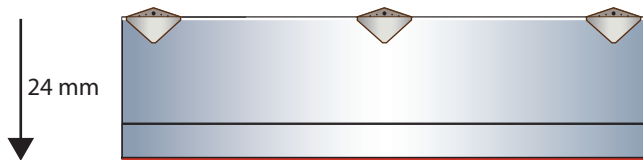

IMPORTANT
Top former is glued 24 mm from top edge of upper body for Starship SN-11 model

IMPORTANT
Top former is glued 42 mm from top edge of upper body for Starship SN-11 model



1 cm

1 inch

1:100 Scale

Starship SN11 Upper Dome

Print on Cardstock (110 lbs)

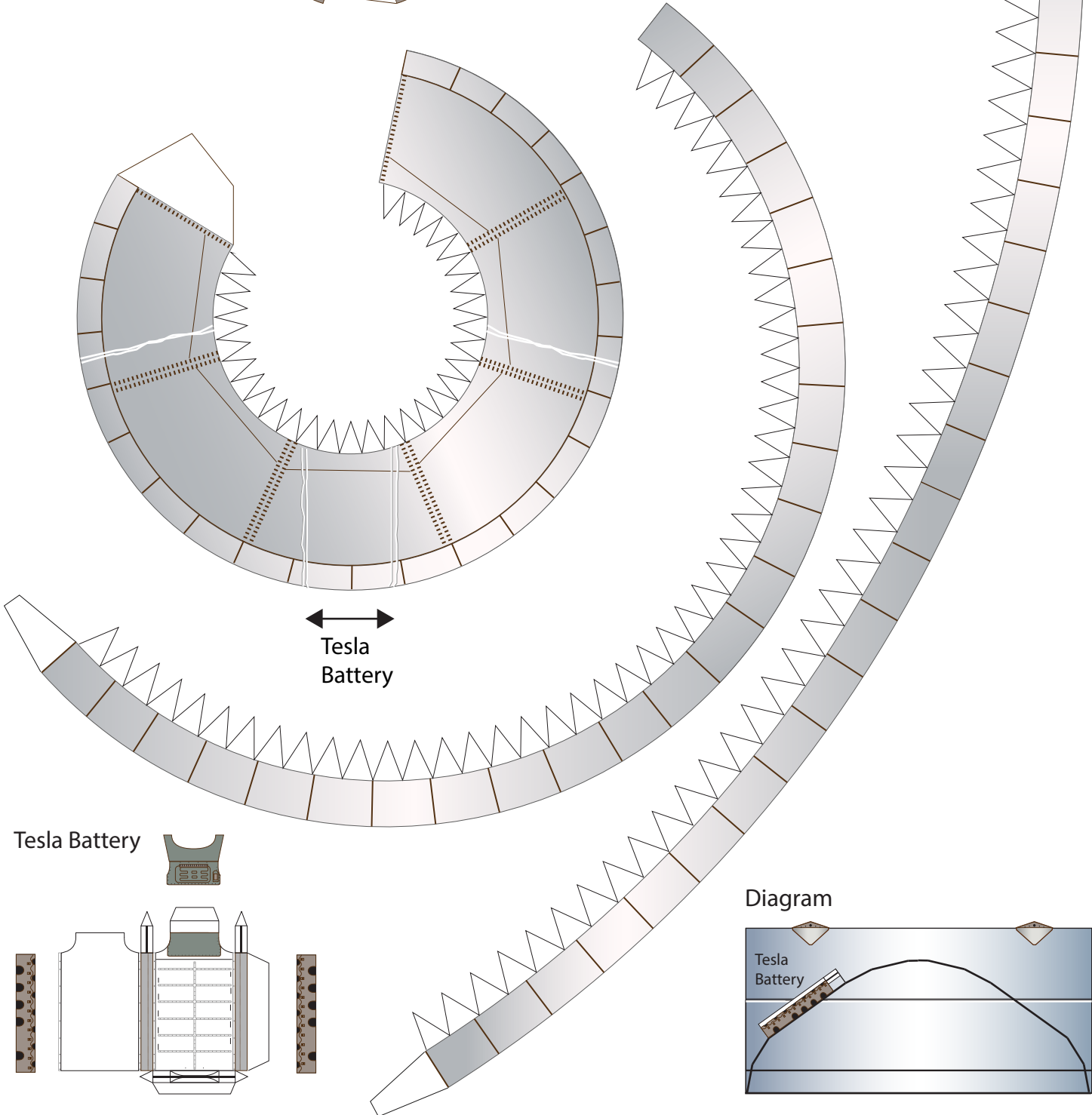
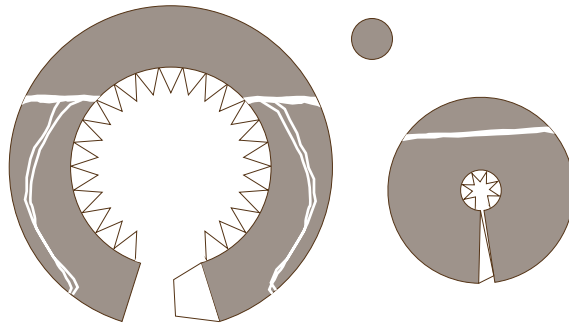

Tesla Battery

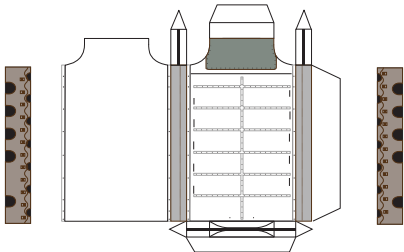

Diagram

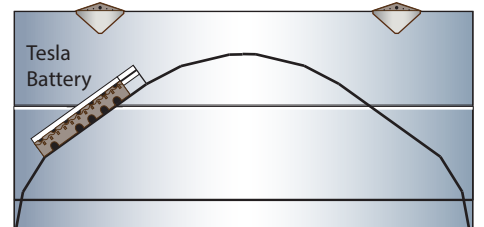



1:100 Scale

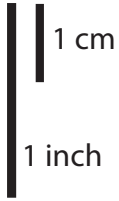

SpaceX Starship SN

Print on Cardstock (110 lbs)

Formers for lower body

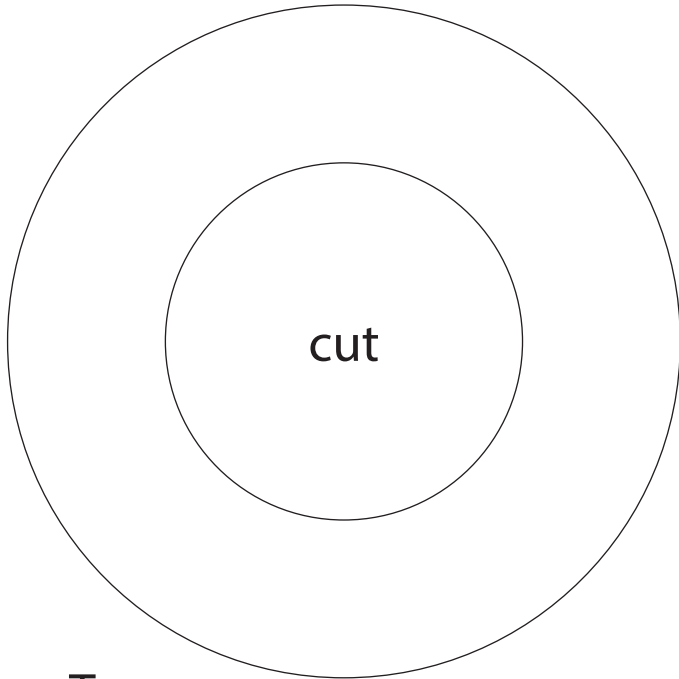

Top

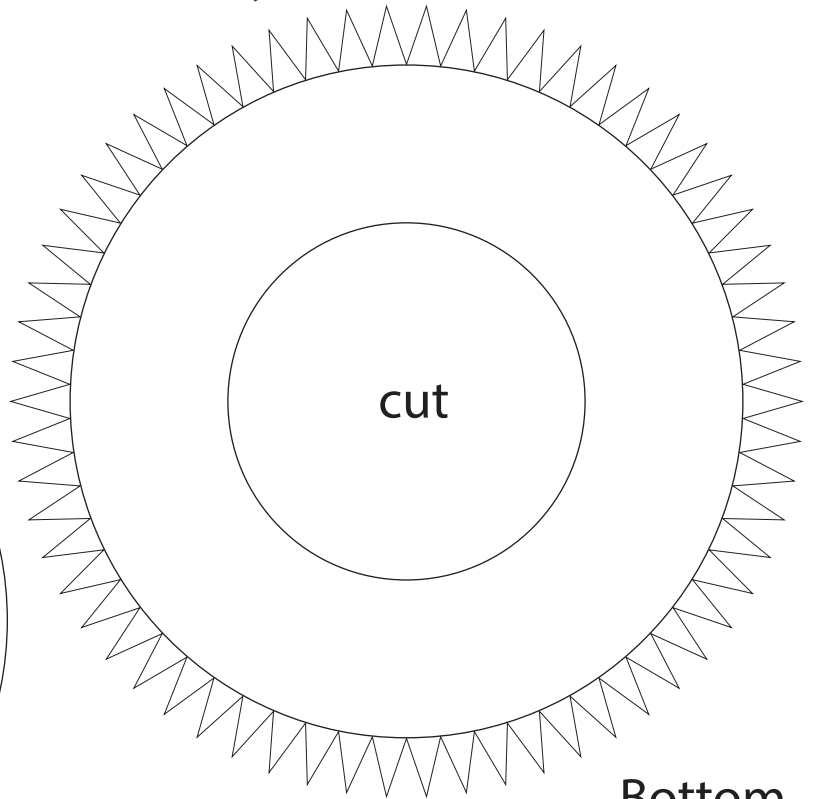

Bottom

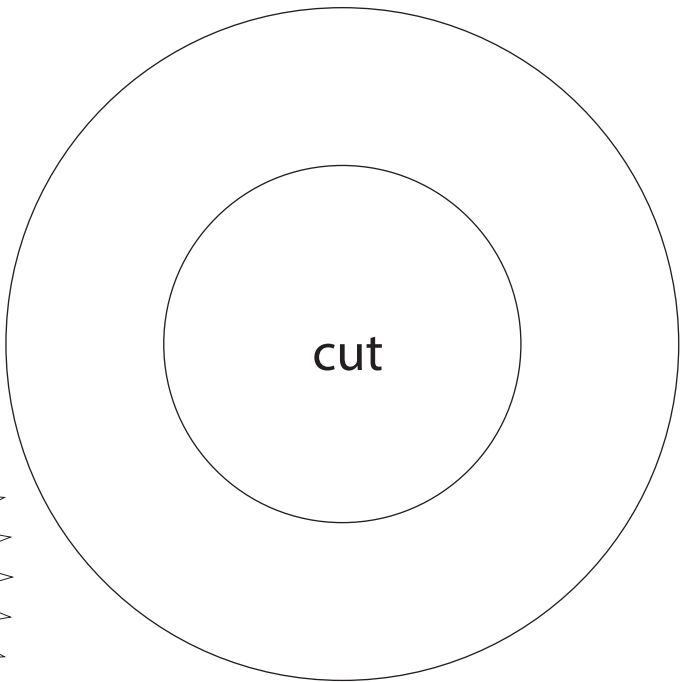
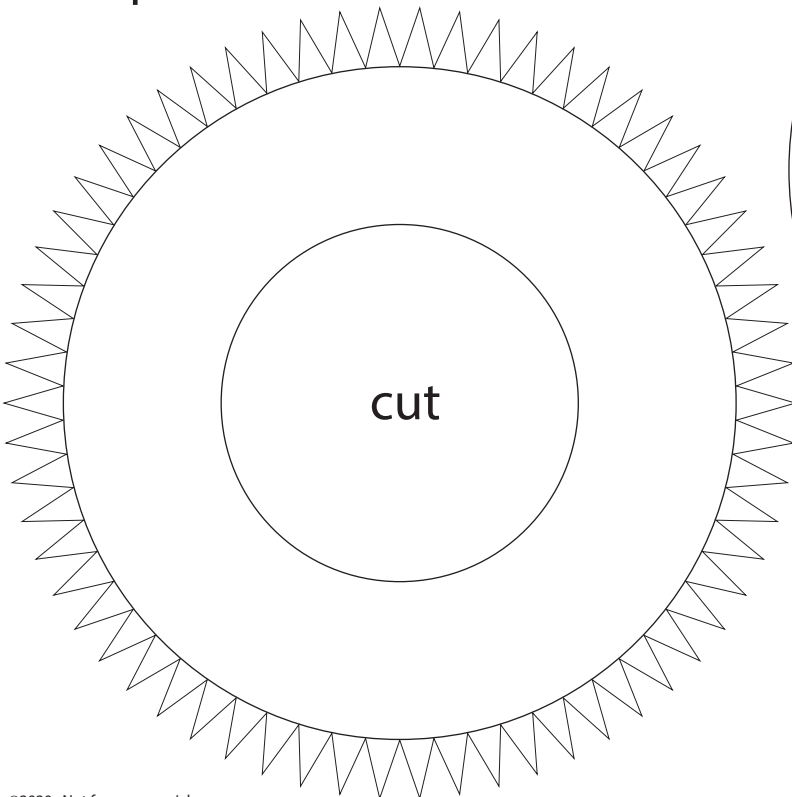

IMPORTANT

Top former is glued 20 mm from bottom edge of upper body.
Bottom former is glued 66 mm from bottom edge of lower body.



1 cm

1 inch

1:100 Scale

Starship SN 11 Bulkhead

Print on Cardstock (110 lbs)

REVISED

Use 4x2 mm Deryun magnets

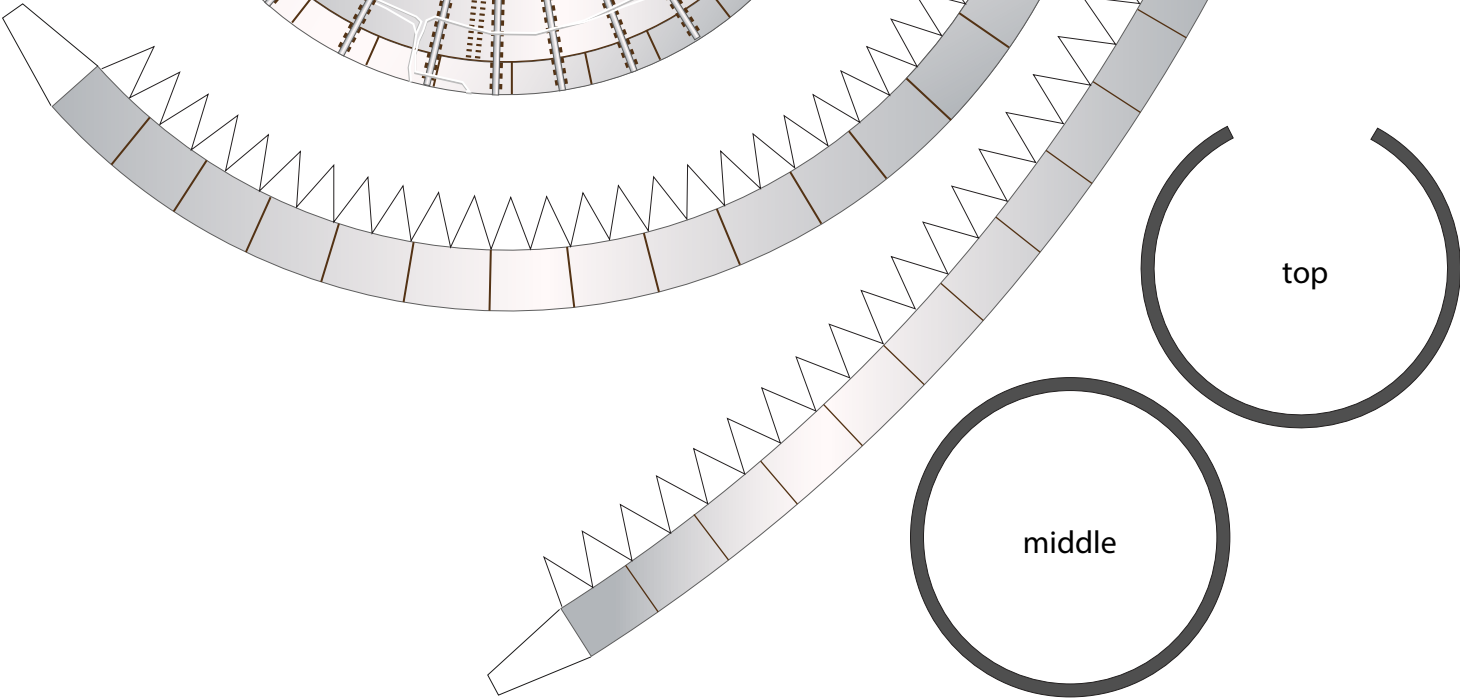
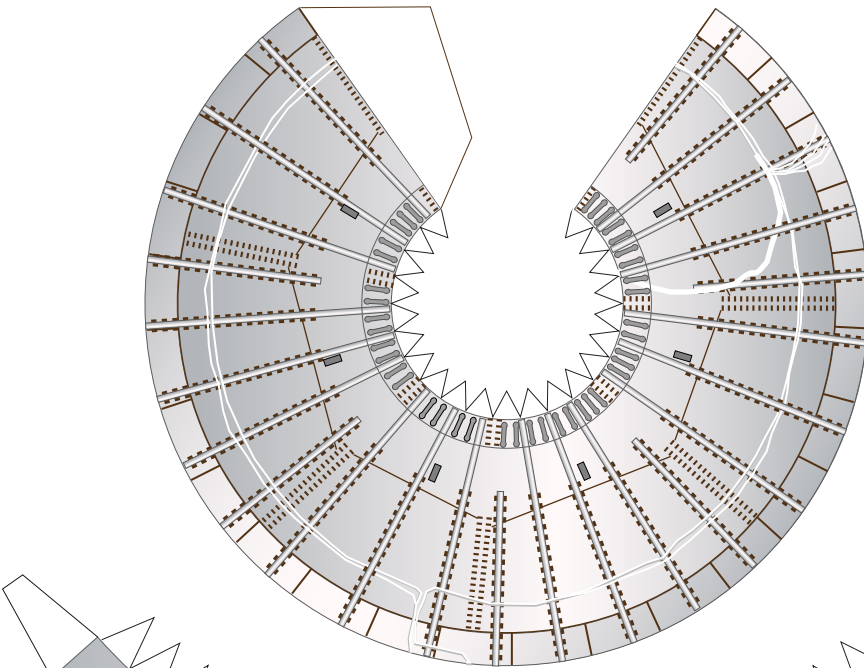
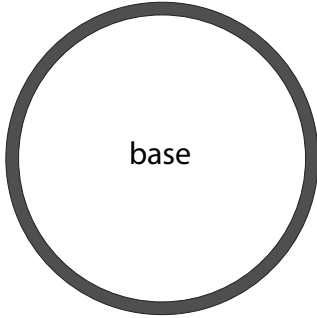
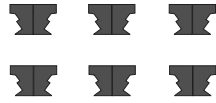
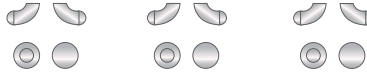
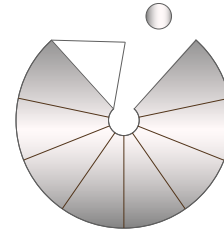
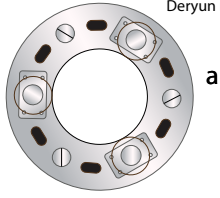
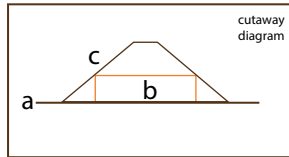



1 cm

1 inch

1:100 Scale

SpaceX Starship SN 11

Print on Cardstock (110 lbs)

Revised

Connectors for
nosecone

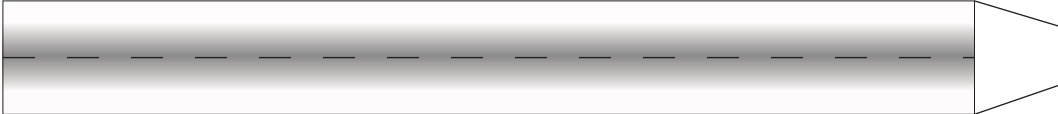
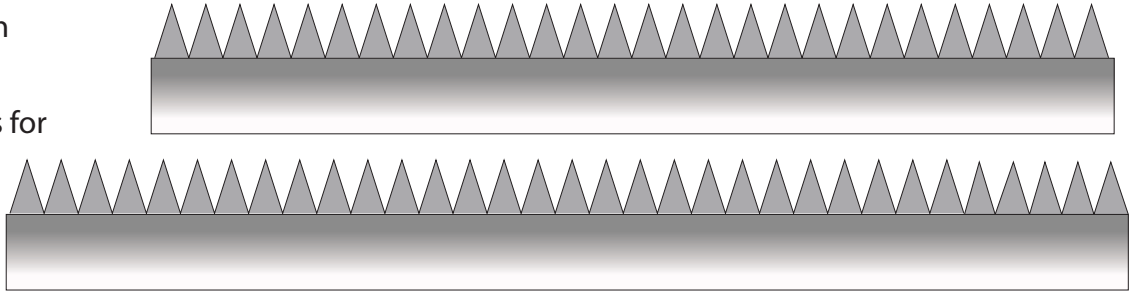

Connectors for upper
and lower body

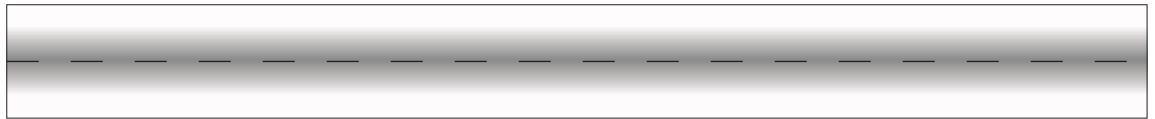

Engine section
interior wall

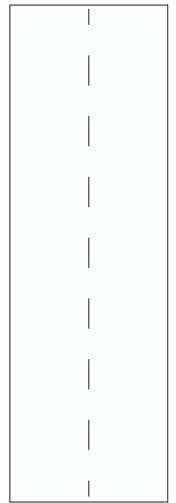
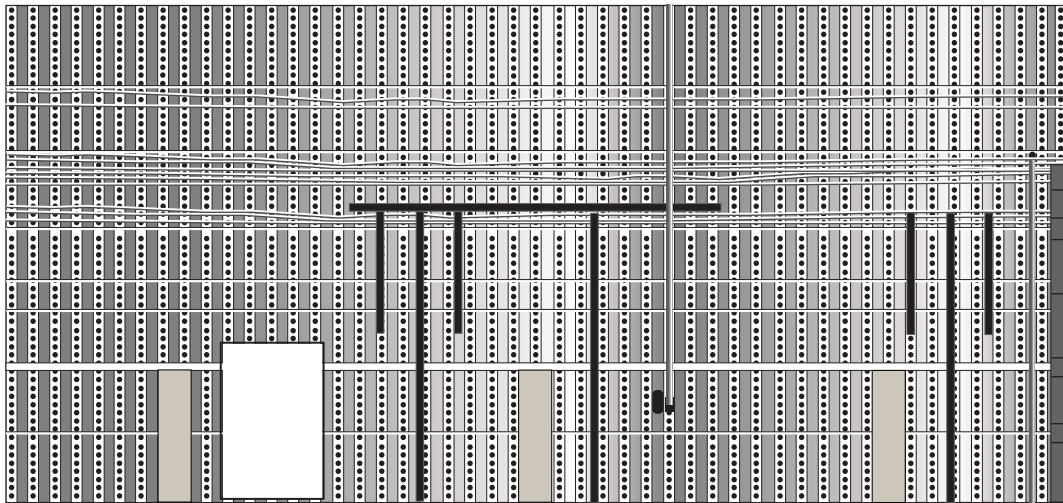
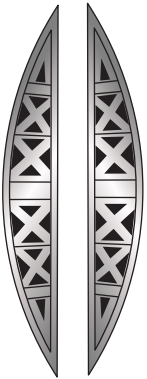

Curve this
segment

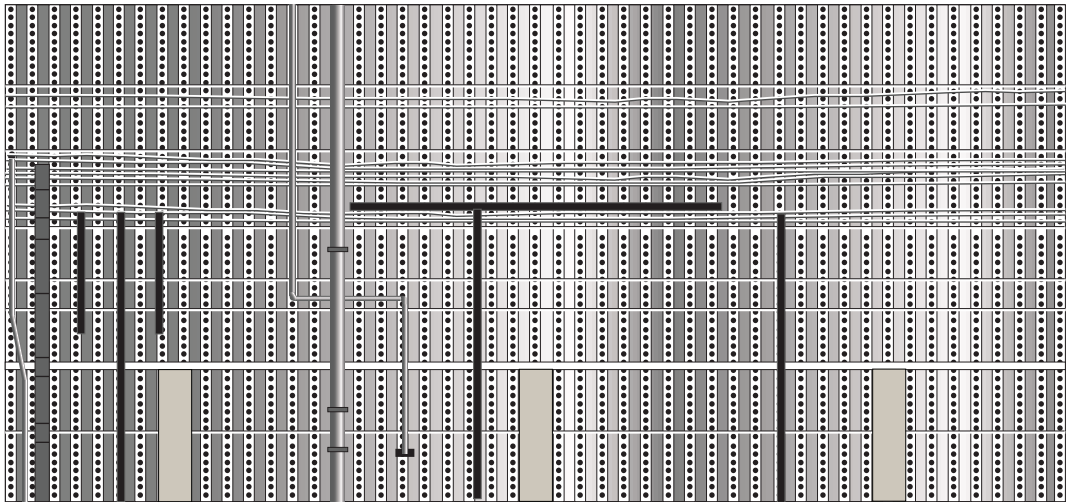
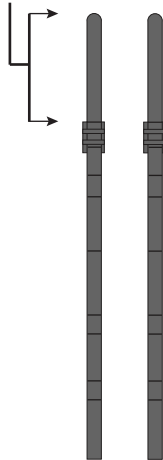
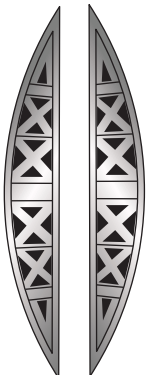

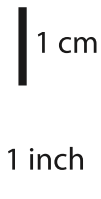

1:100 Scale

COPVs

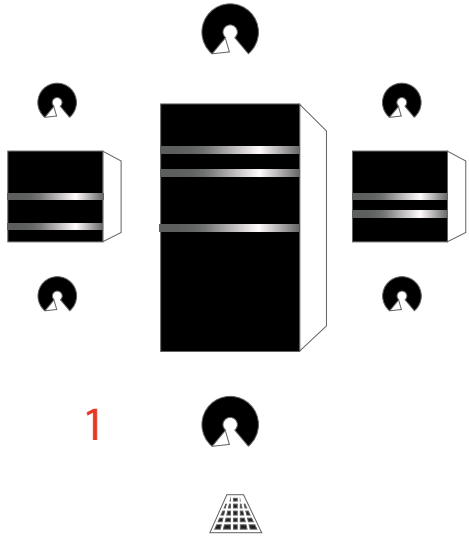

1

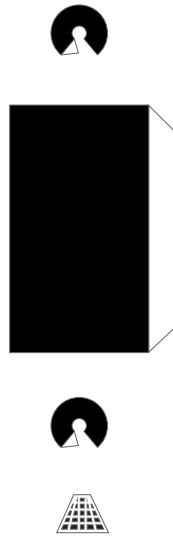

2

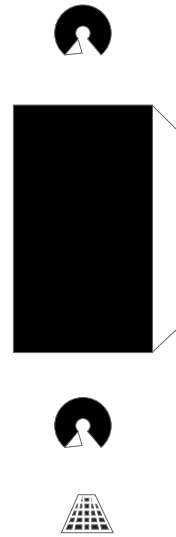

5

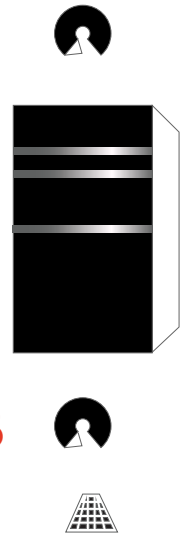

6

This box artwork was used with permission from @DStarship3 designer Yoan Soilen

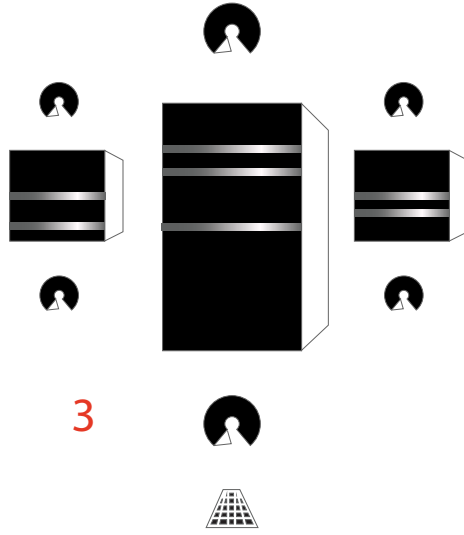
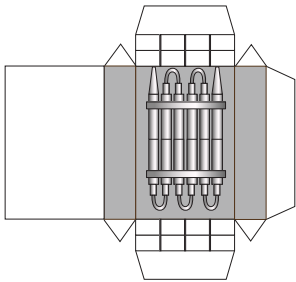

3

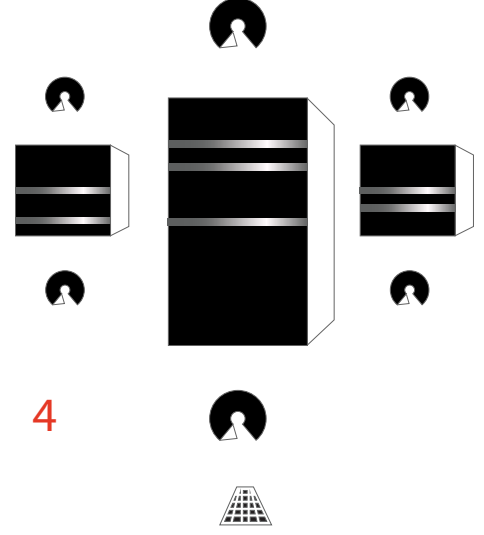

4

Diagram

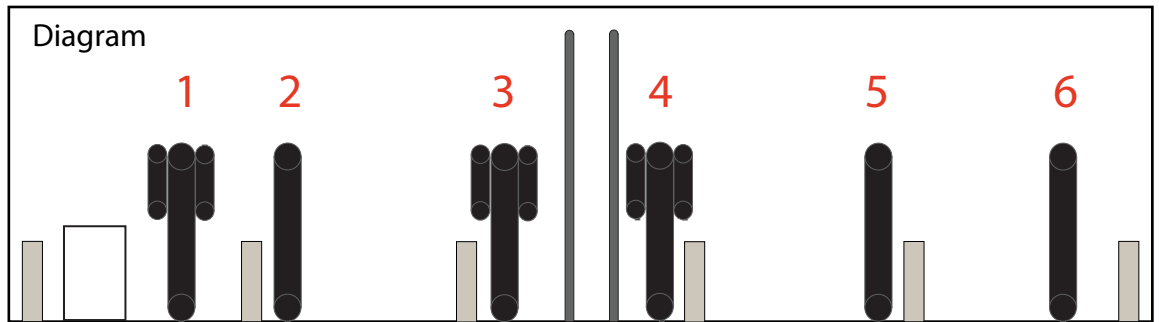

Middle of back area

Use aluminum foil to cover all COPVs and Power box



1 cm
1 inch

SpaceX Starship SN 11

Print on Cardstock (110 lbs)

Landing Legs

Revised

1:100 Scale

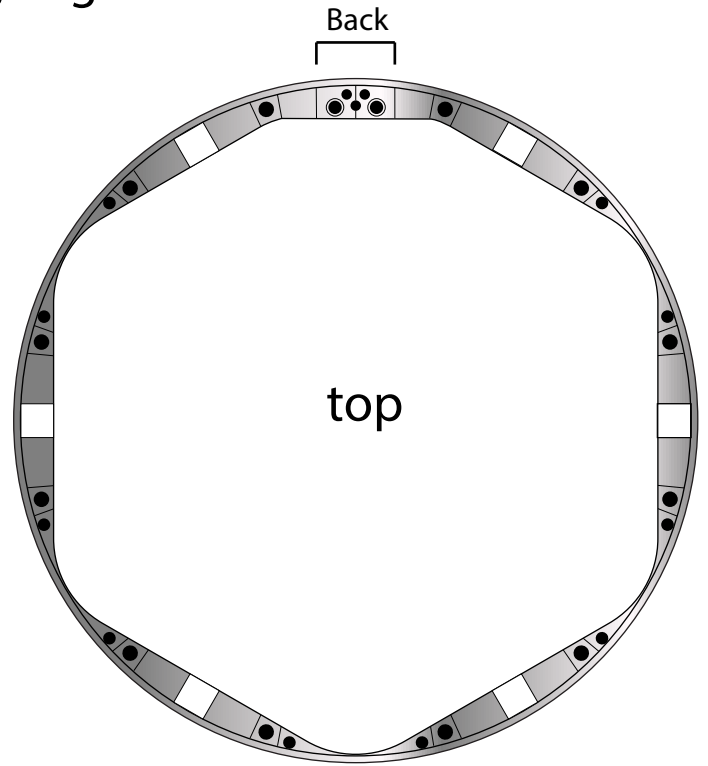
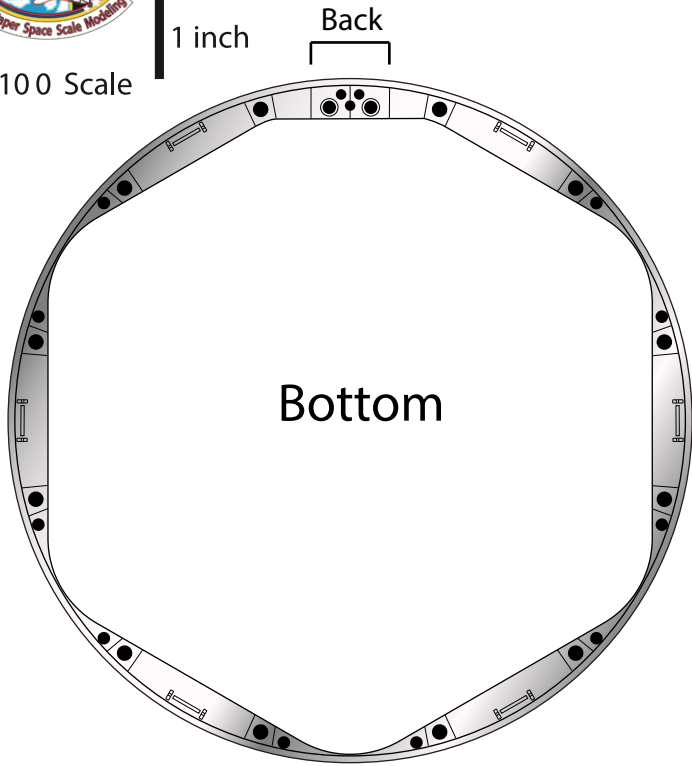

Leg support pillars

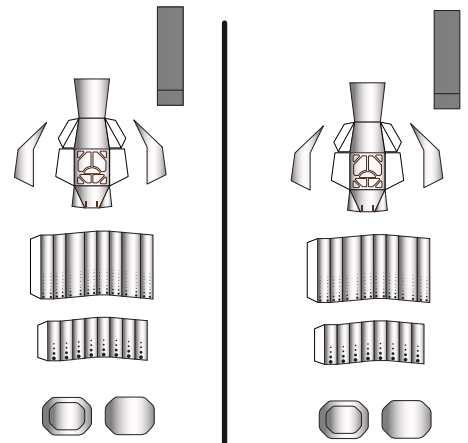
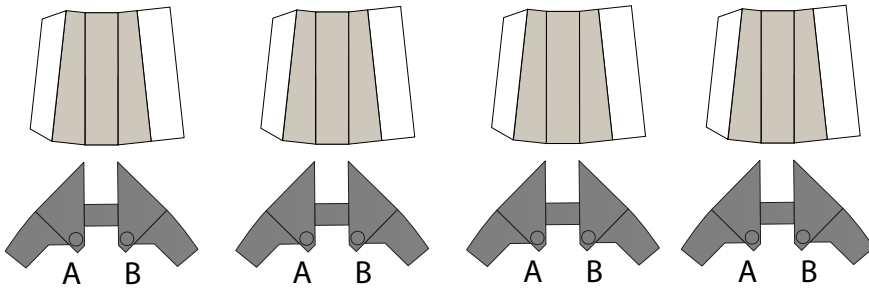

Landing Legs

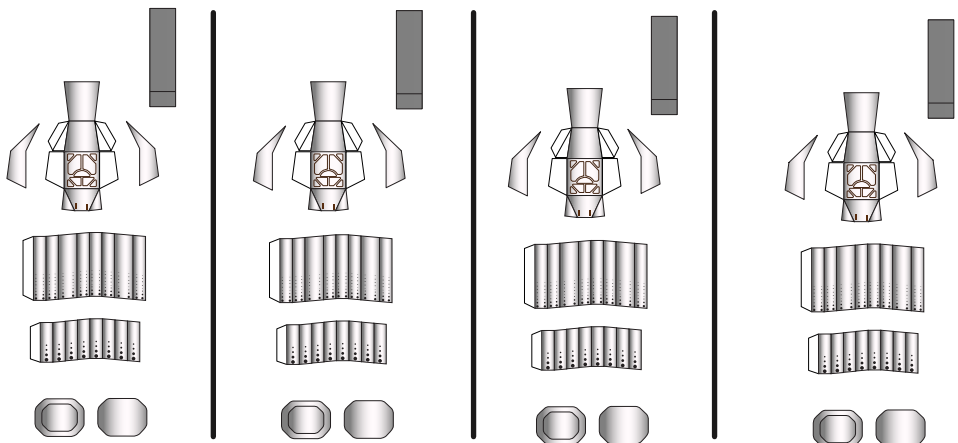
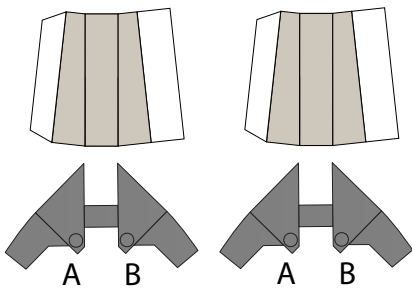

Use a cottonswab stick (2 mm diameter) and cut 6 segments of 5 mm in length and glue them between parts A and B.



1 cm

1 inch

1:100 Scale

SpaceX Starship Raptors

Print on Cardstock (110 lbs)

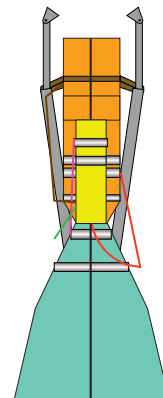
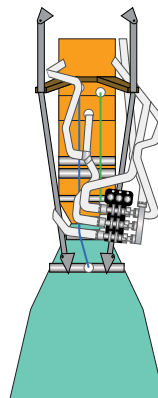
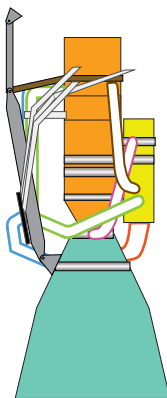
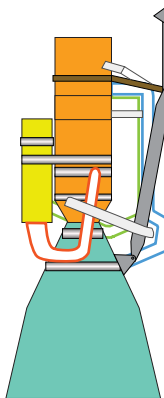
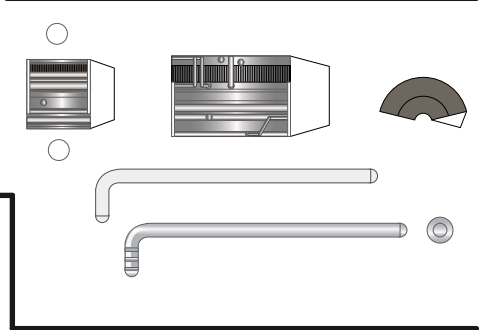
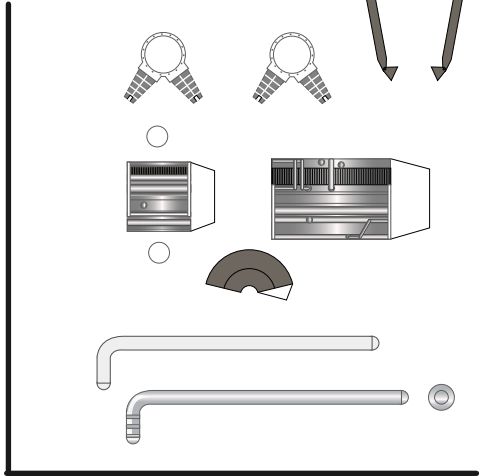
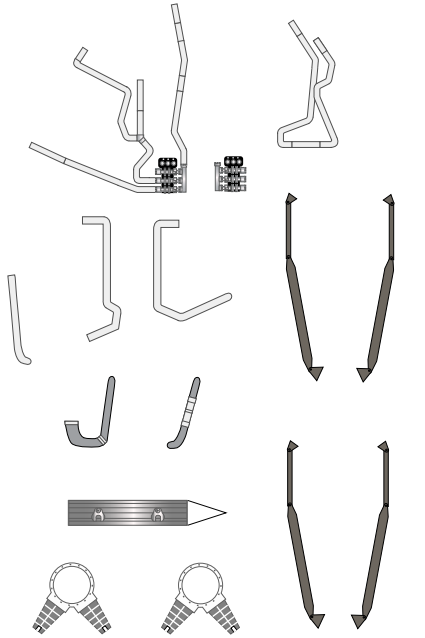
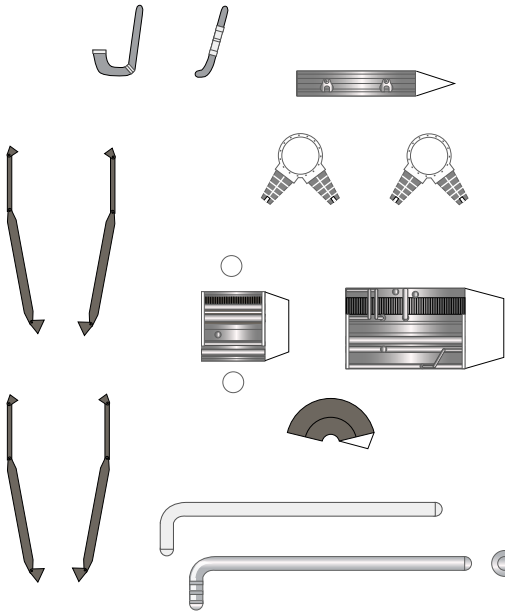
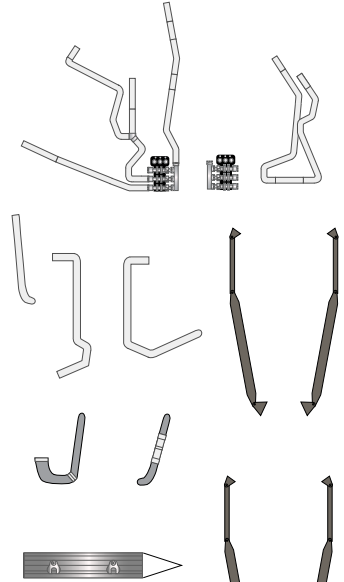
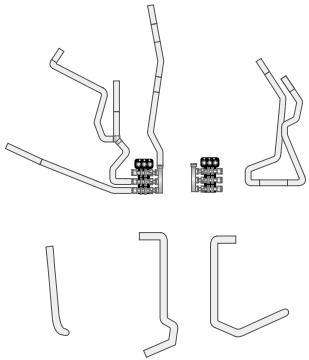
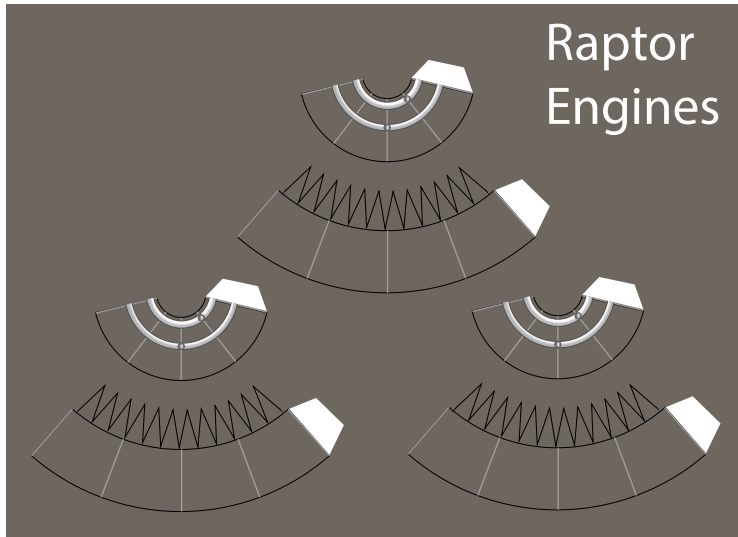





1:100 Scale

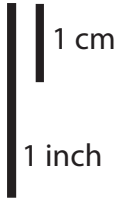

SpaceX Starship SN 11

Print on Cardstock (110 lbs)

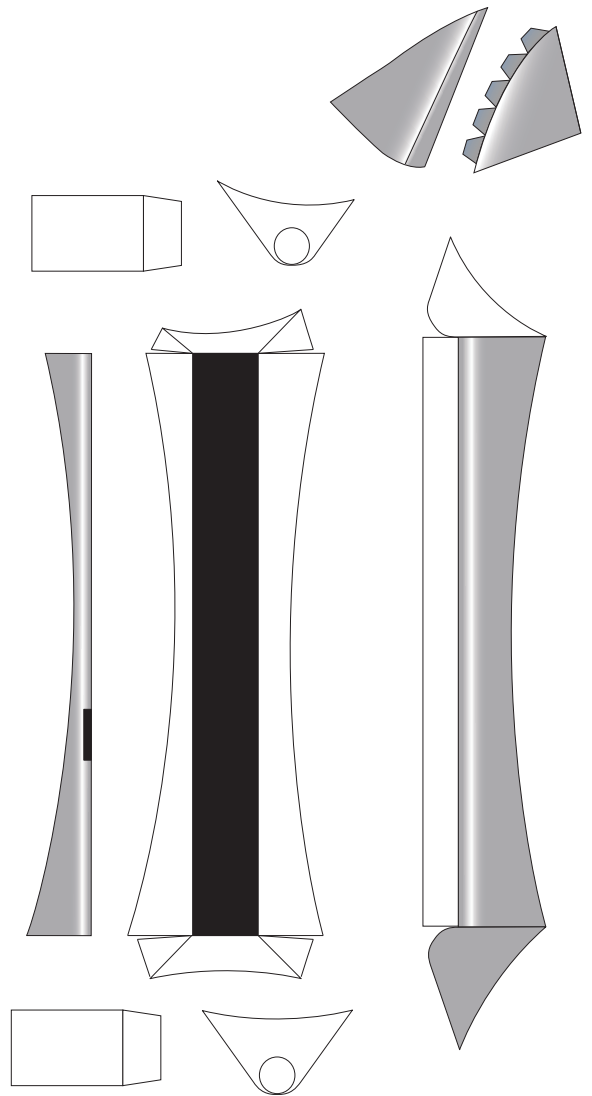
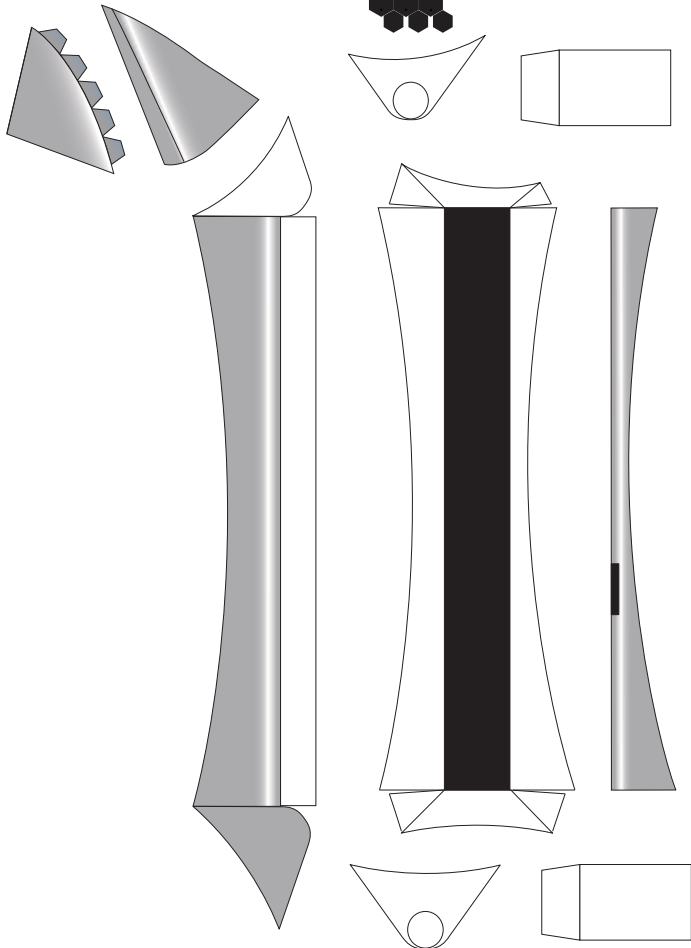
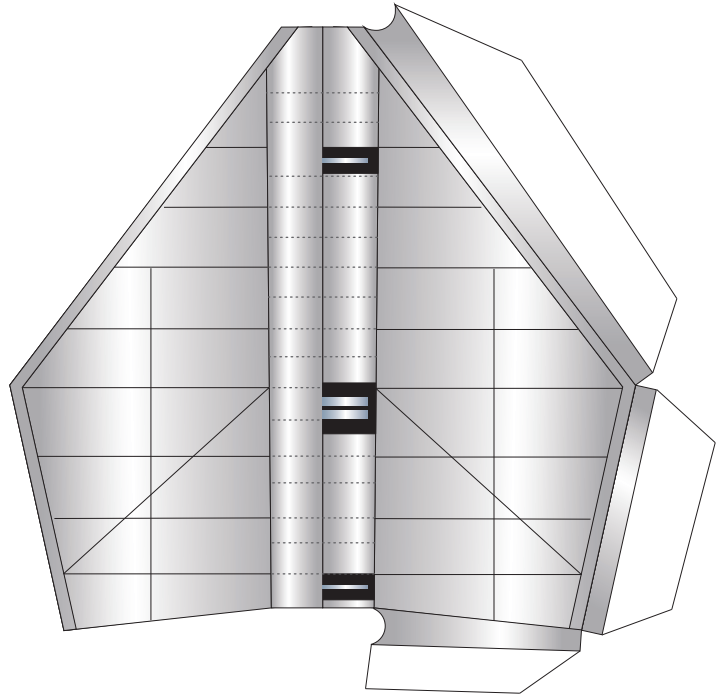
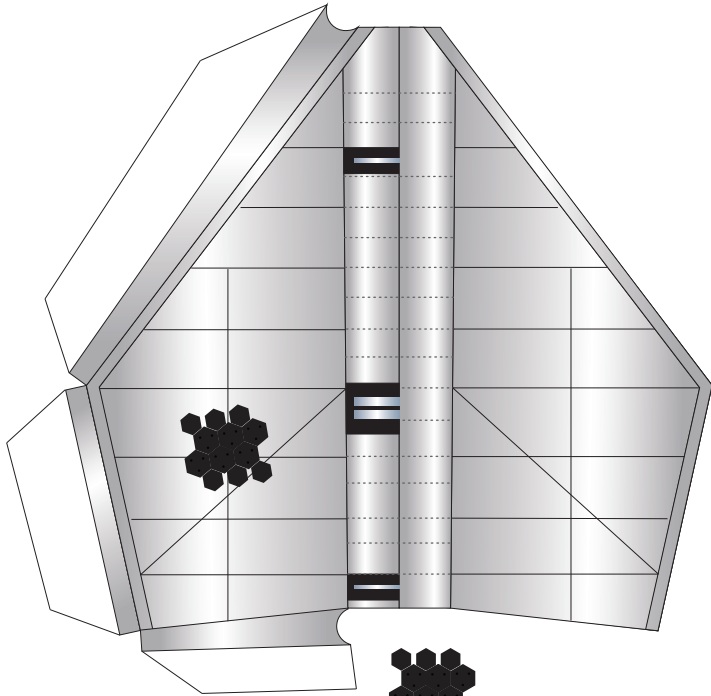



1:100 Scale



SpaceX Starship SN 11

Print on Cardstock (110 lbs)

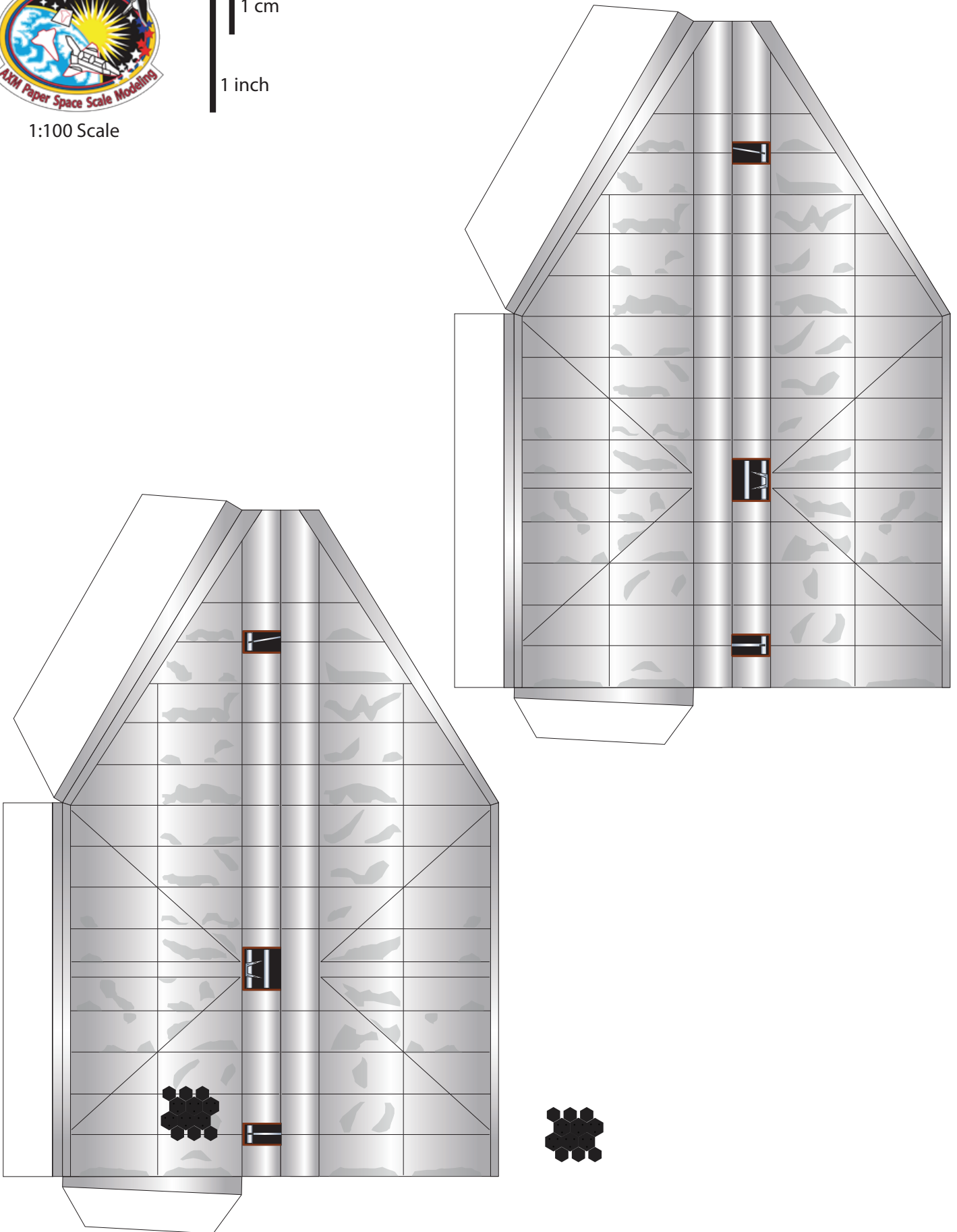



1:100 Scale

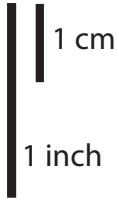

SpaceX Starship SN

Print on Cardstock (110 lbs)

Revised

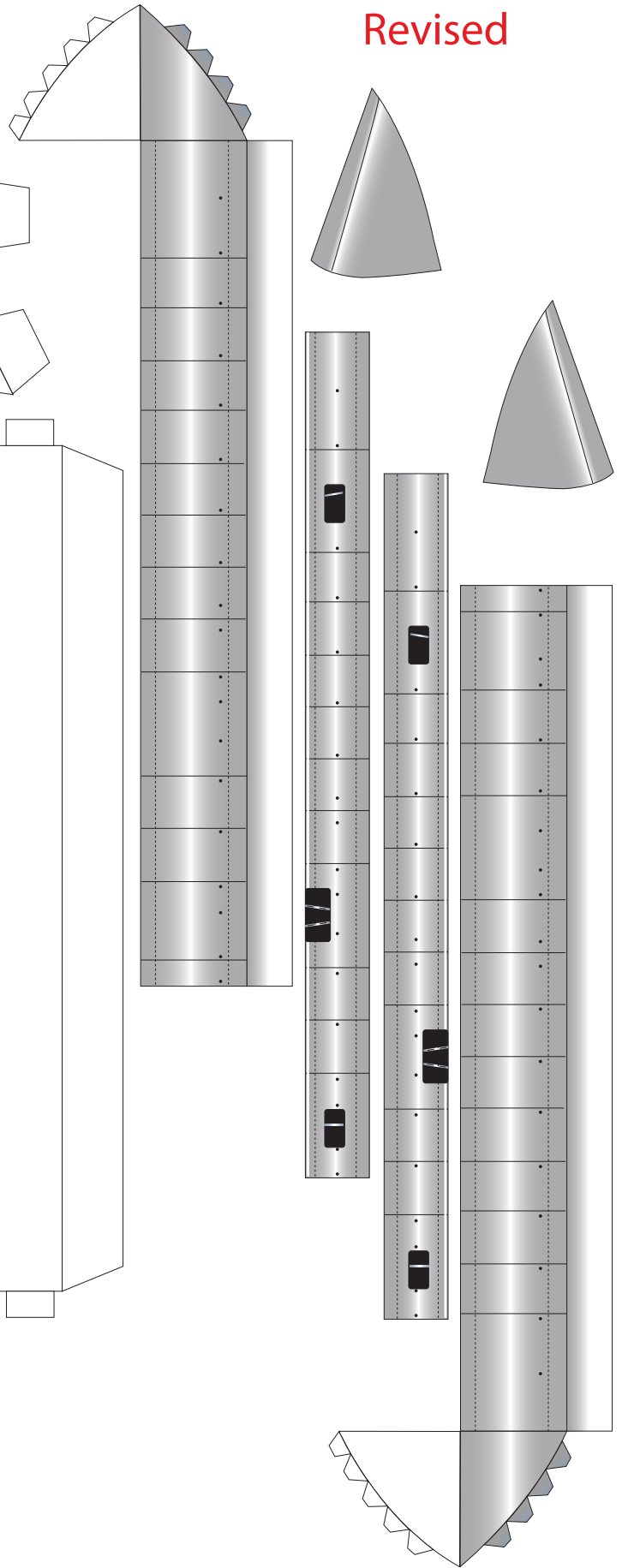
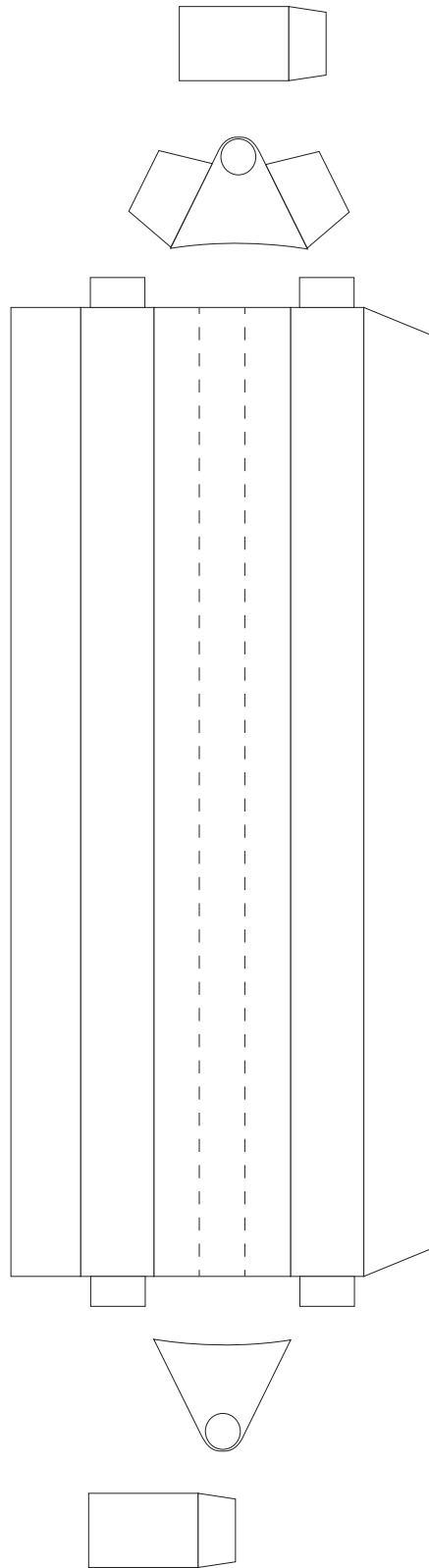
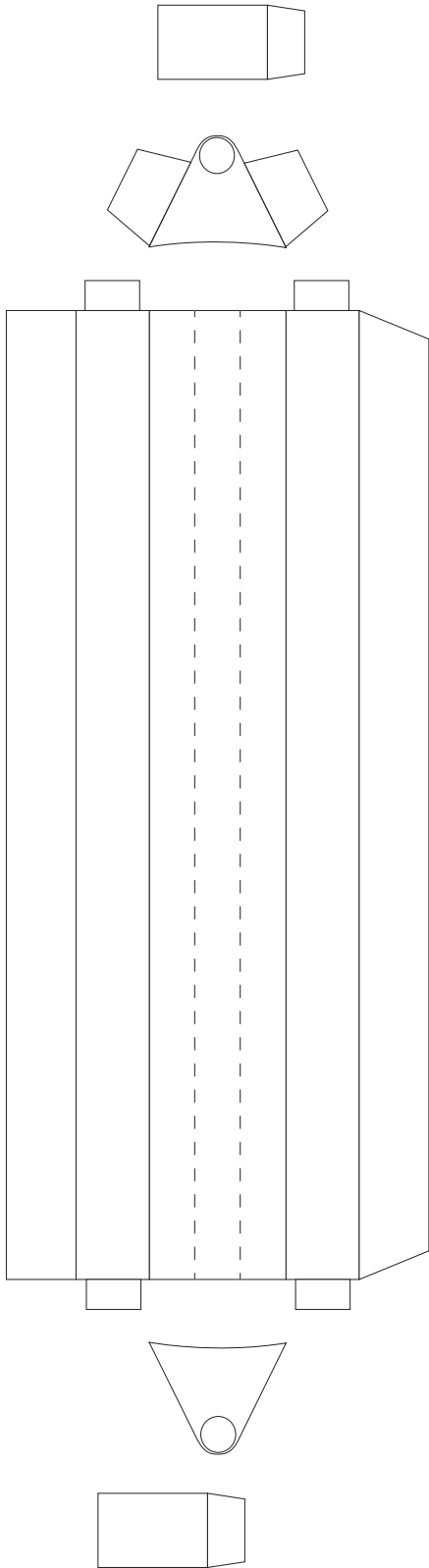



1:100 Scale



SpaceX Starship SN

Print on Cardstock (110 lbs)

(Optional)

Header Tank

Nosecone interior parts in red.

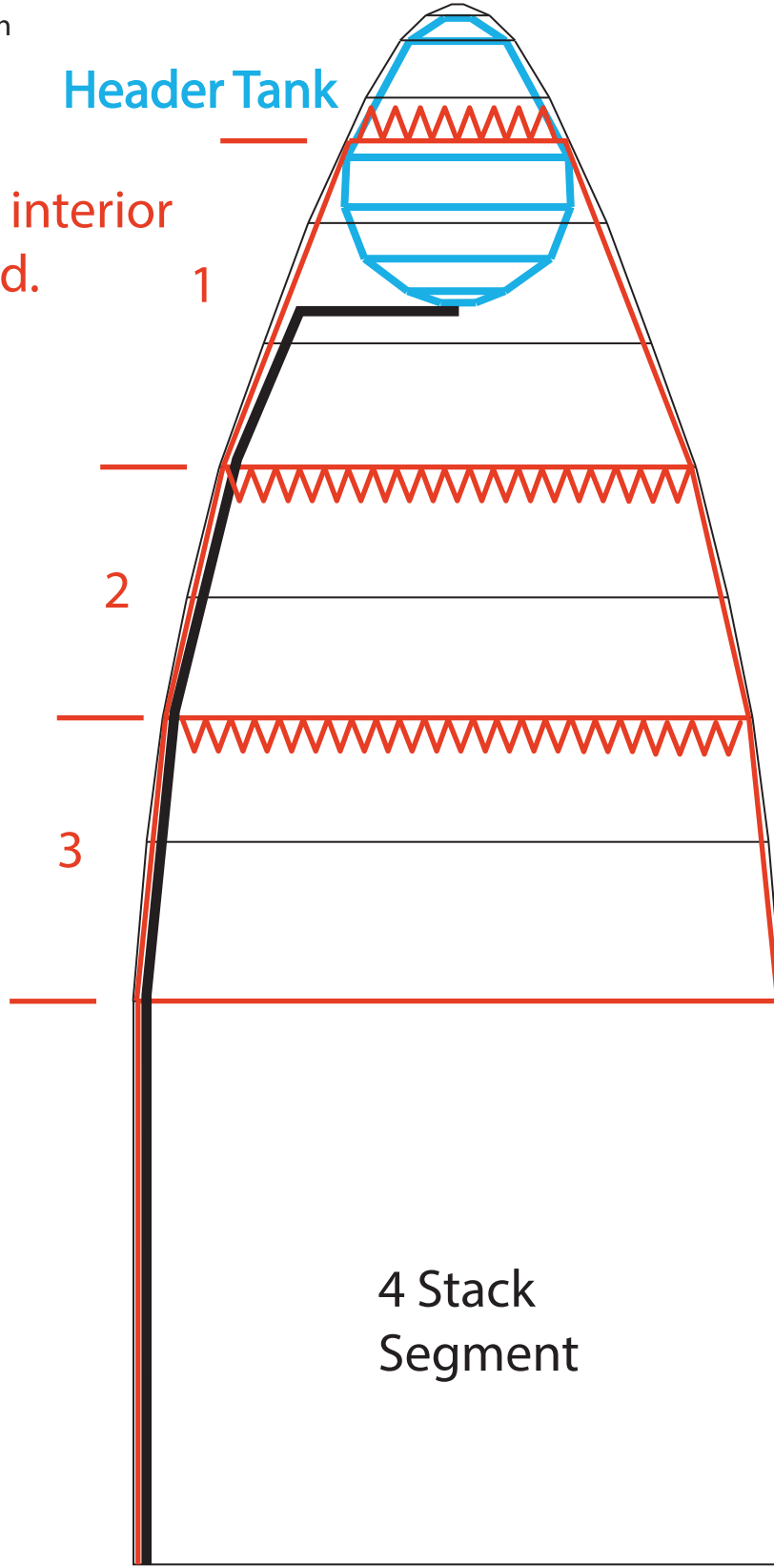

Header Tank pipe

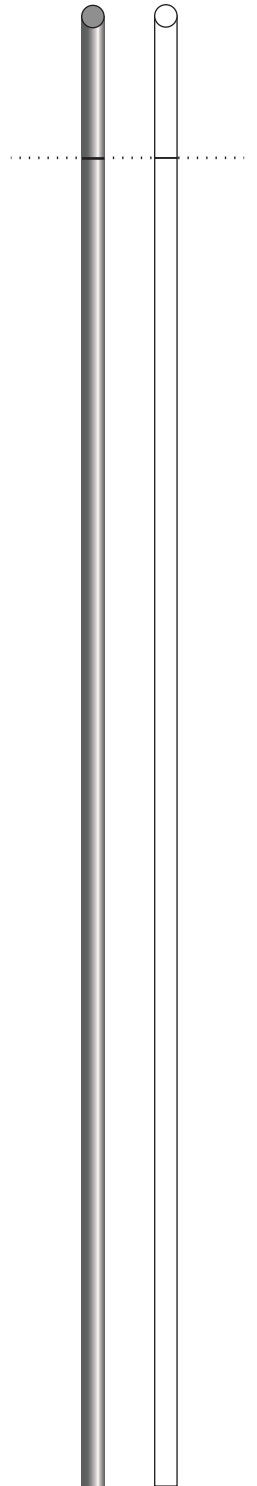



1:100 Scale



SpaceX Starship SN Nosecone interior

Print on Cardstock (110 lbs)

(Optional)

Nosecone interior parts in red.

1

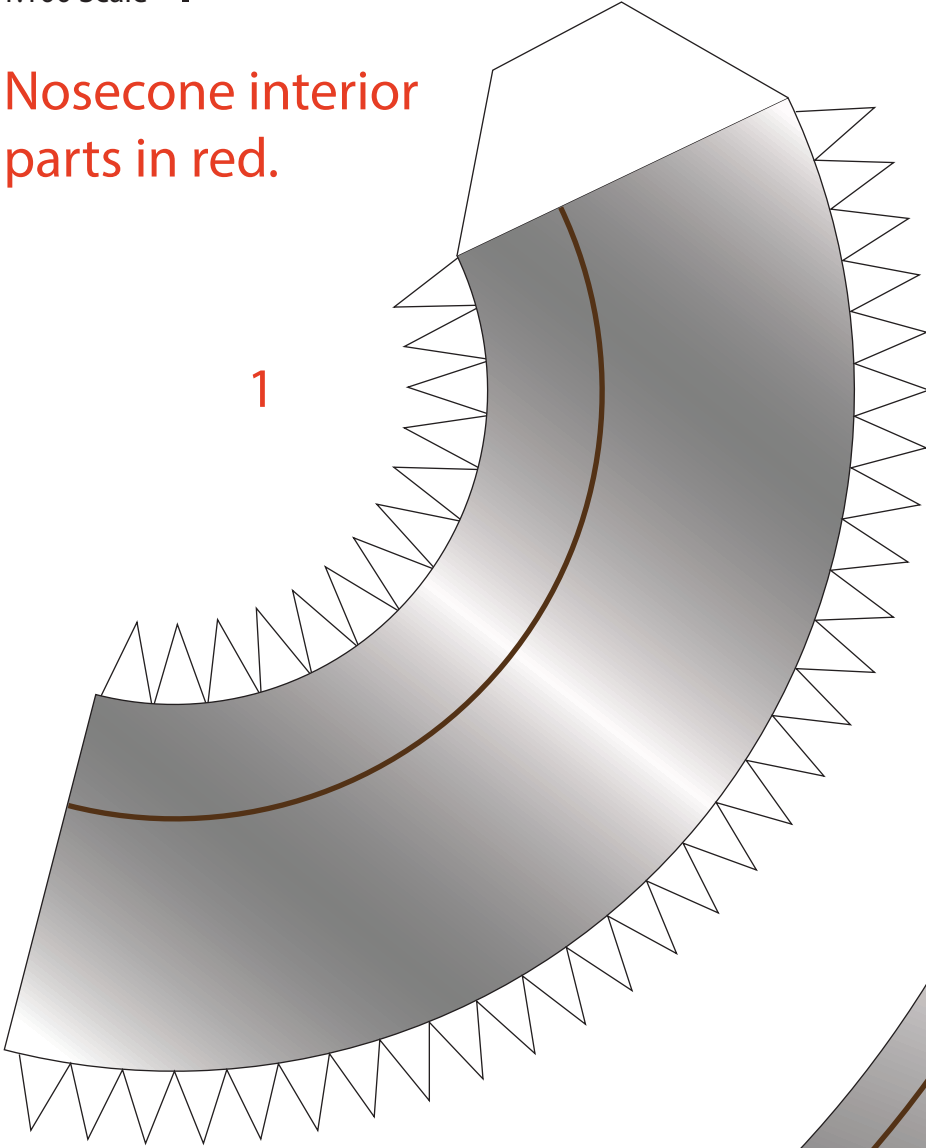

2

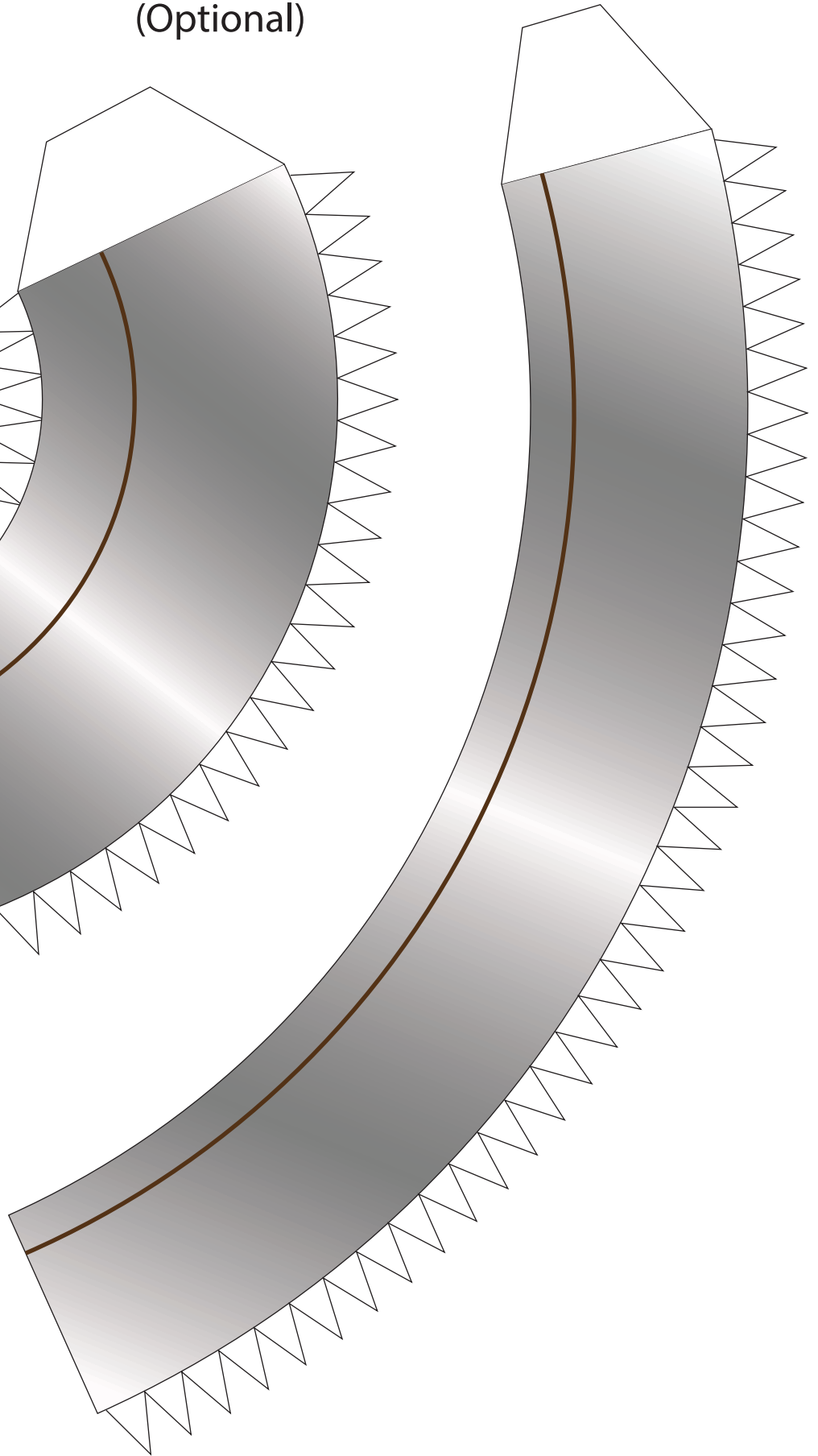



1:100 Scale



SpaceX Starship SN Header Tank

Print on Cardstock (110 lbs)

(Optional)

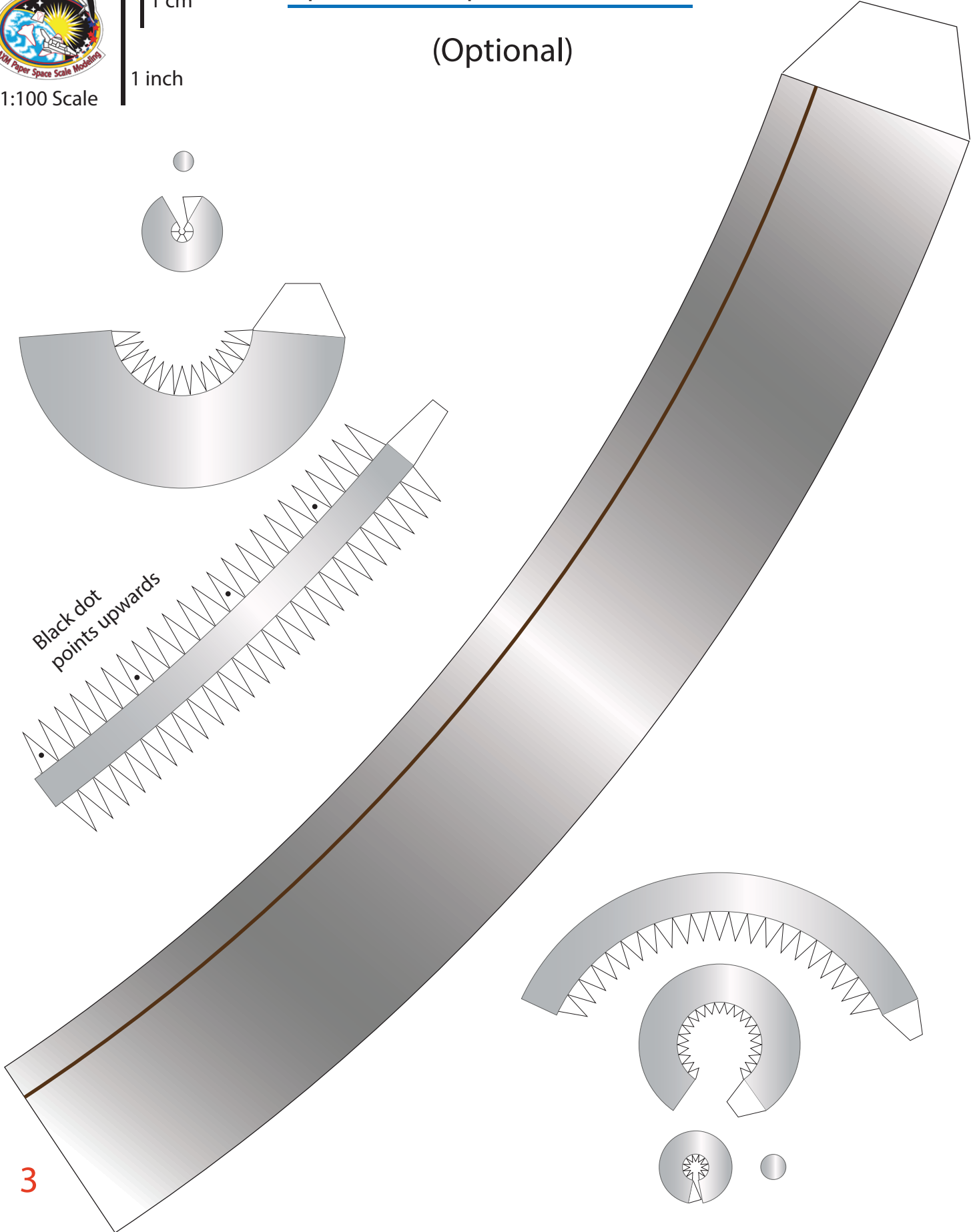

3



1 cm

1 inch

1:100 Scale

SpaceX Starship SN11

Print on Cardstock (110 lbs)

Nosecone-body 4 ring stack interior detail

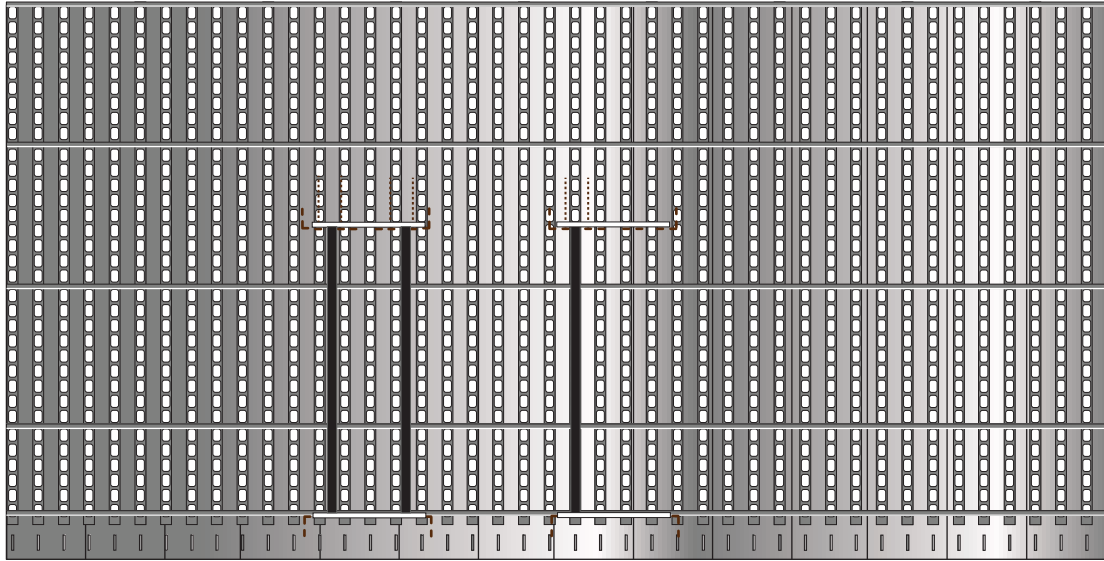
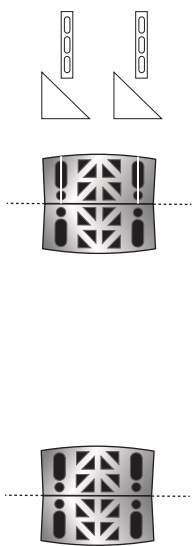

The nosecone interior detail with COPV's was obtained from photos of the Starship 3D model from @DStarship3 designer Yoan Soilen, who gave permission to be included on the AXM Starship design.

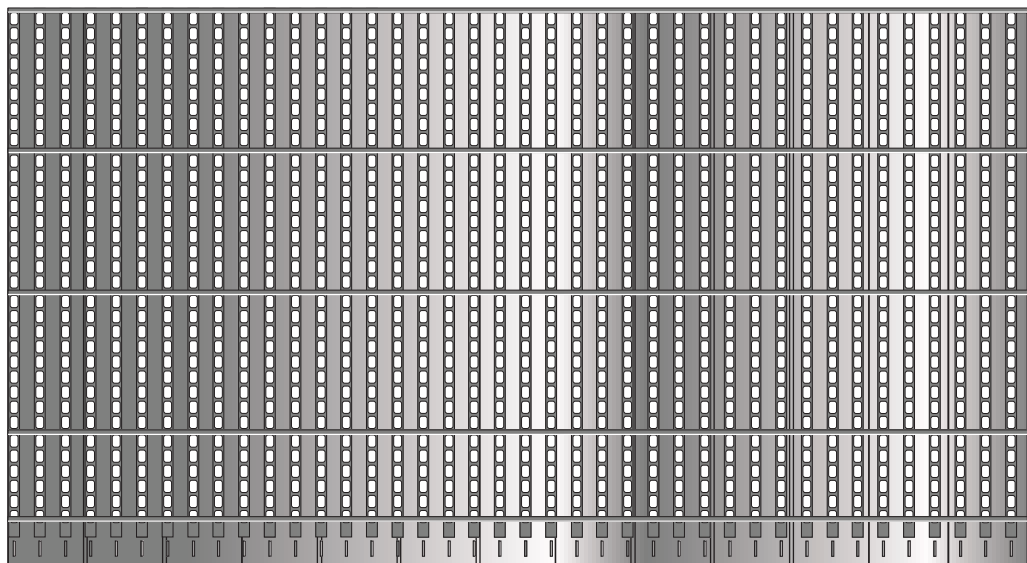
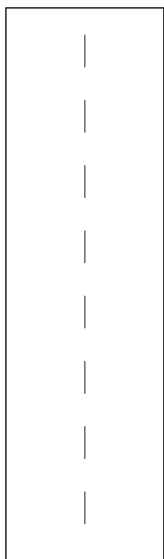
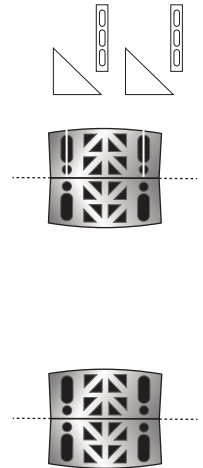
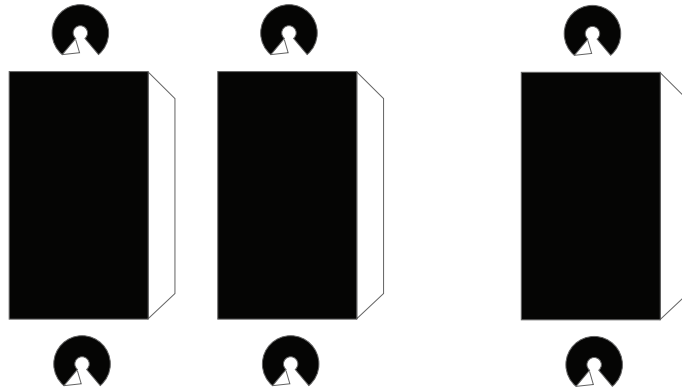



1 cm
1 inch

SpaceX Starship SN11

Print on Cardstock (110 lbs)

REFERENCE

NOT TO SCALE

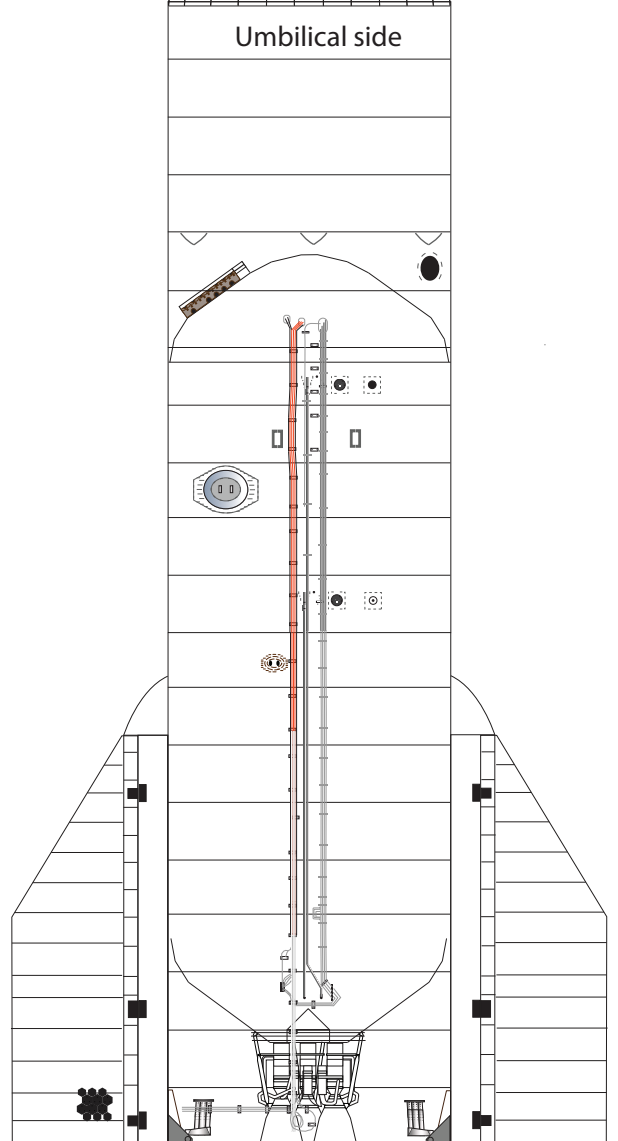
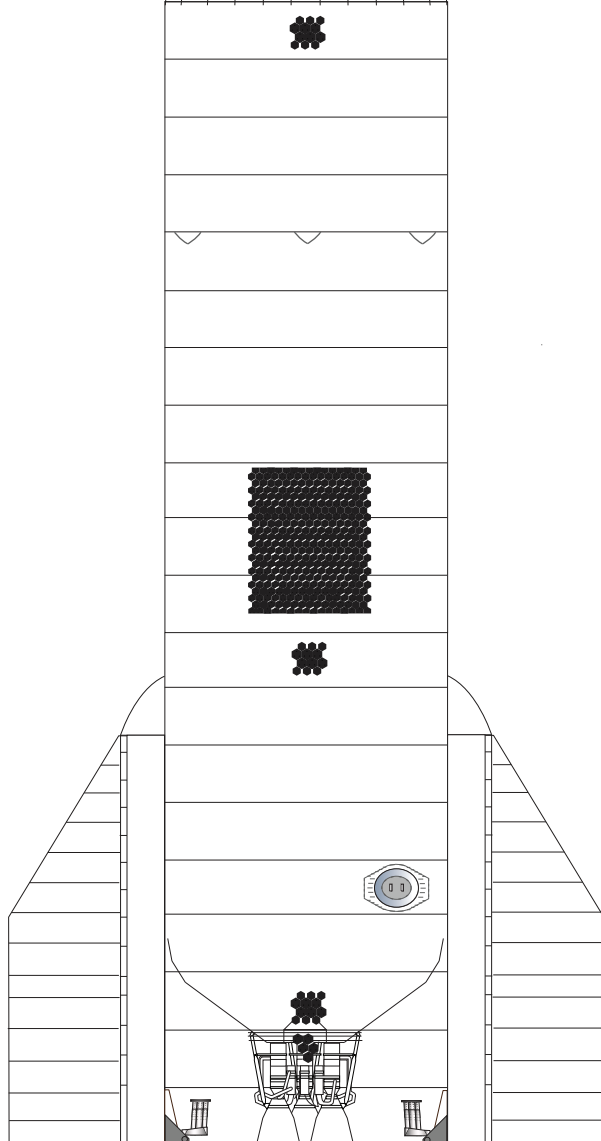
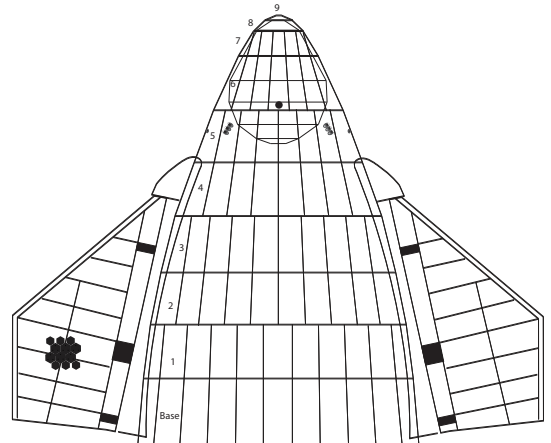
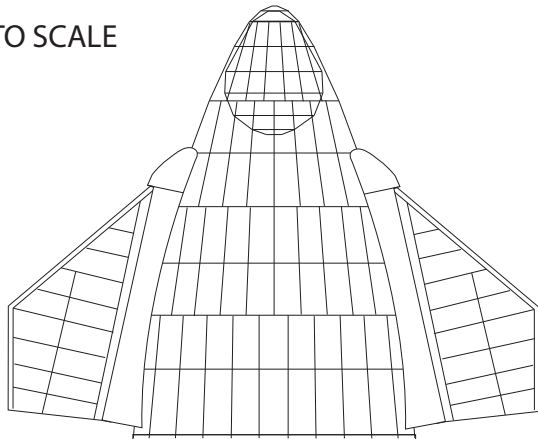

Front

Back