

*4

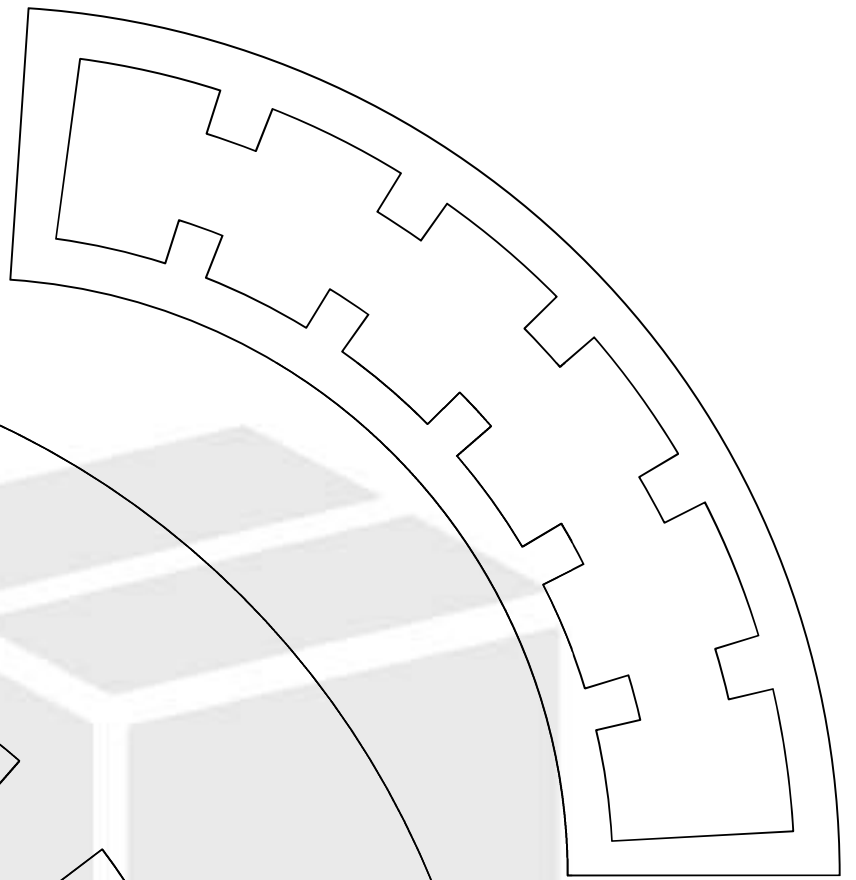

*4

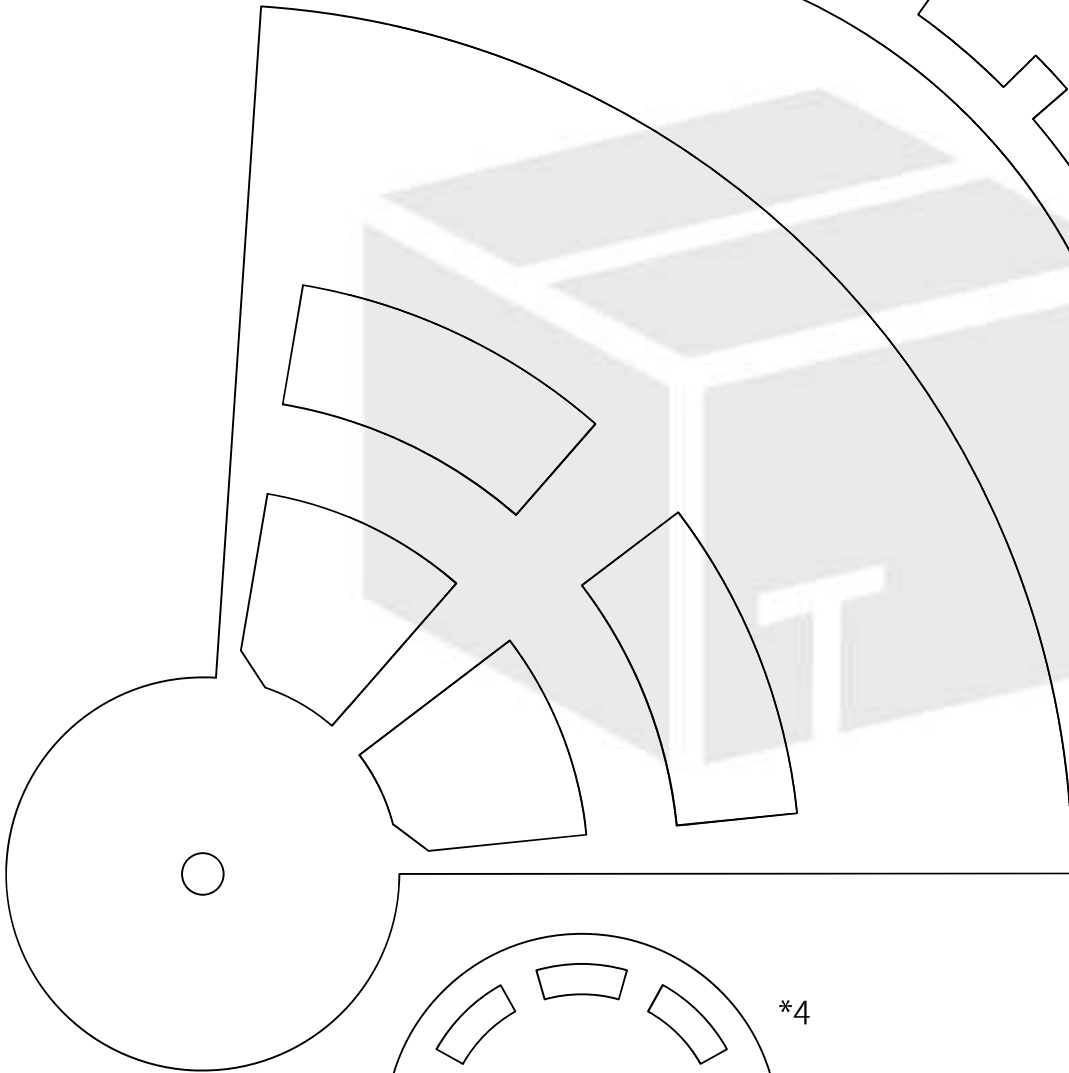

*4

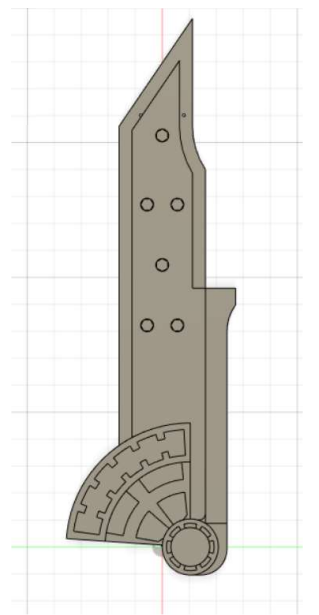
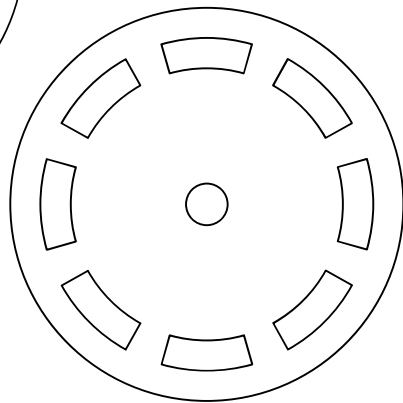

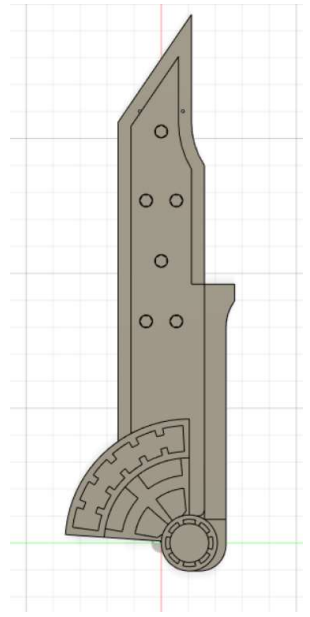
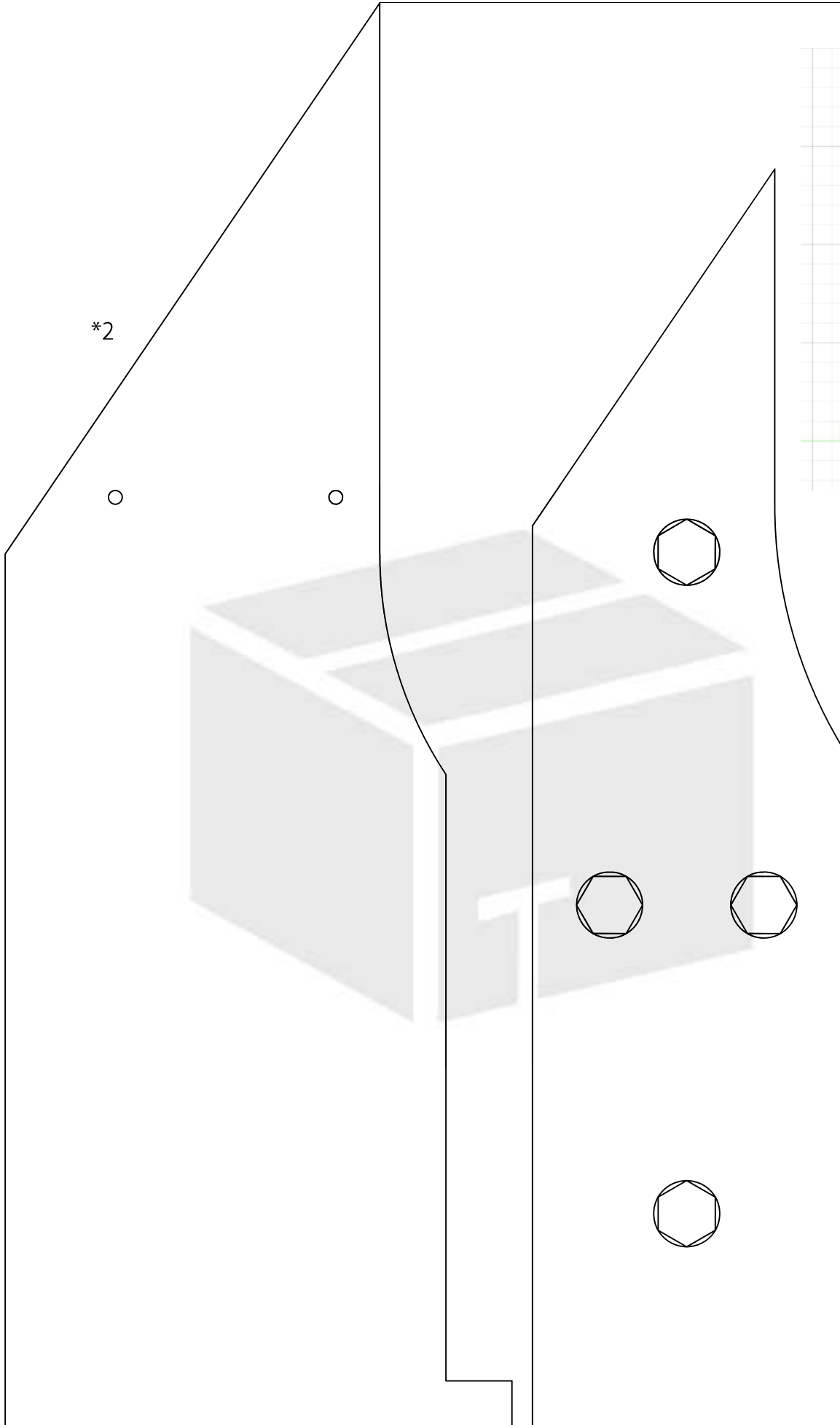

516mm

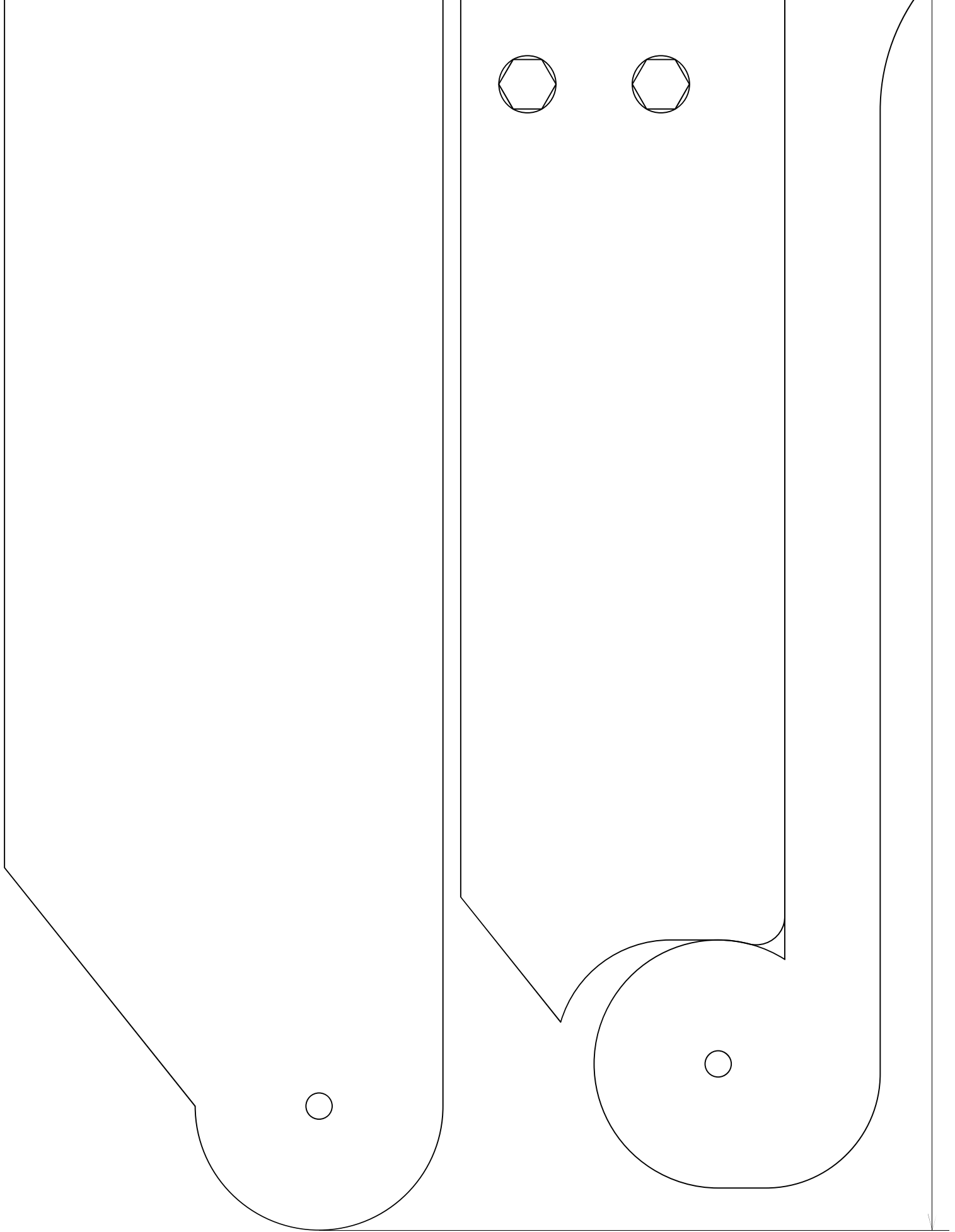

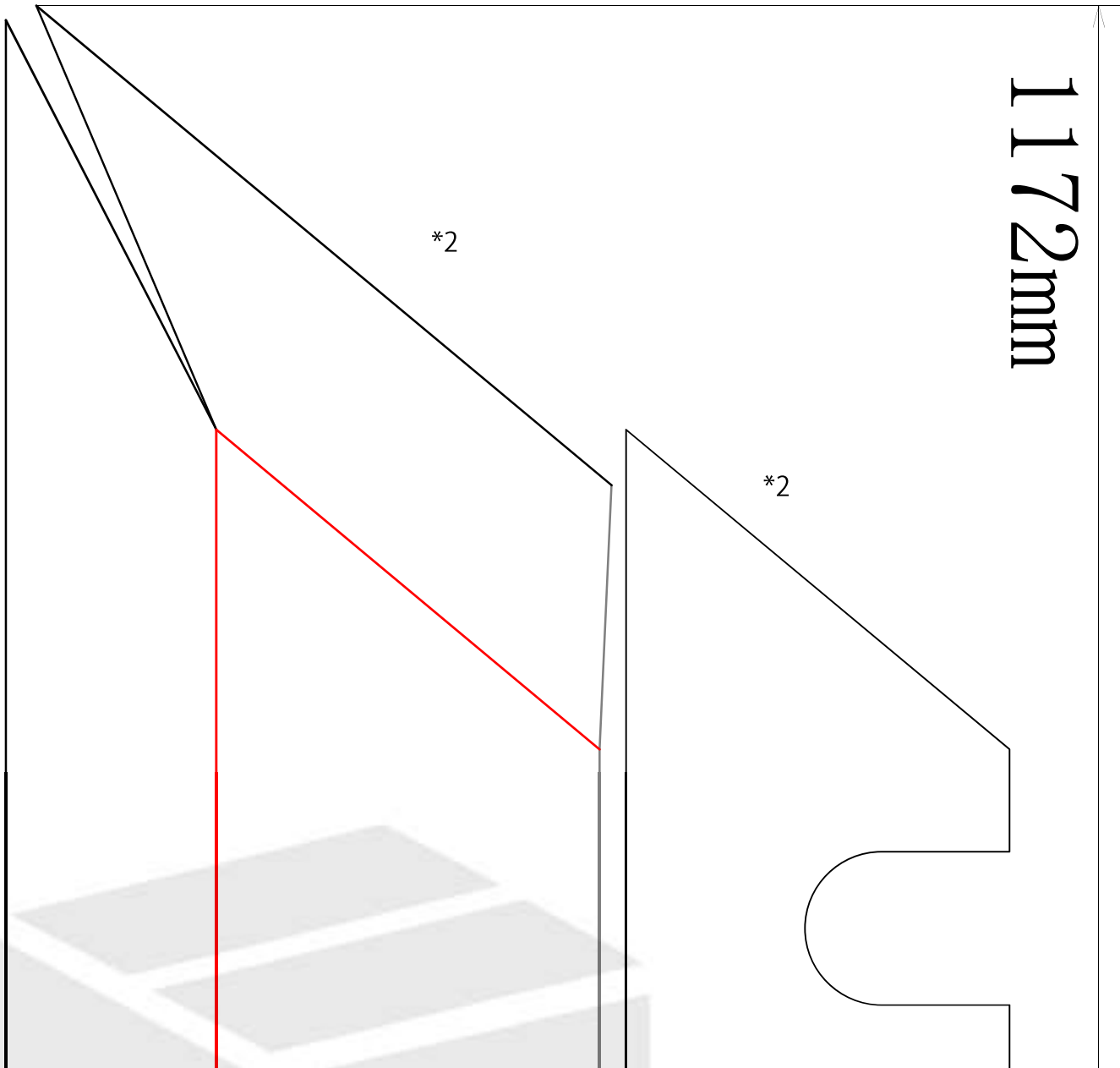
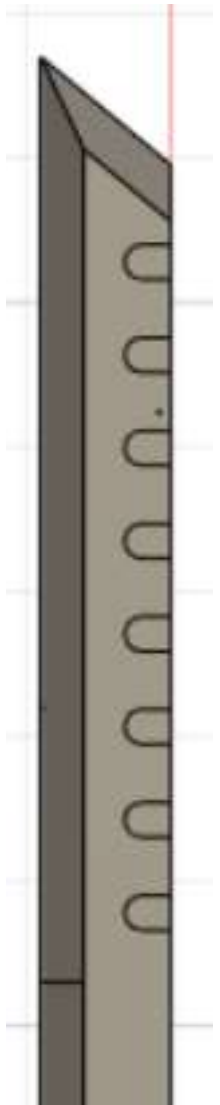

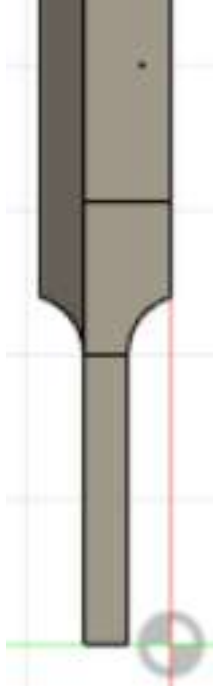
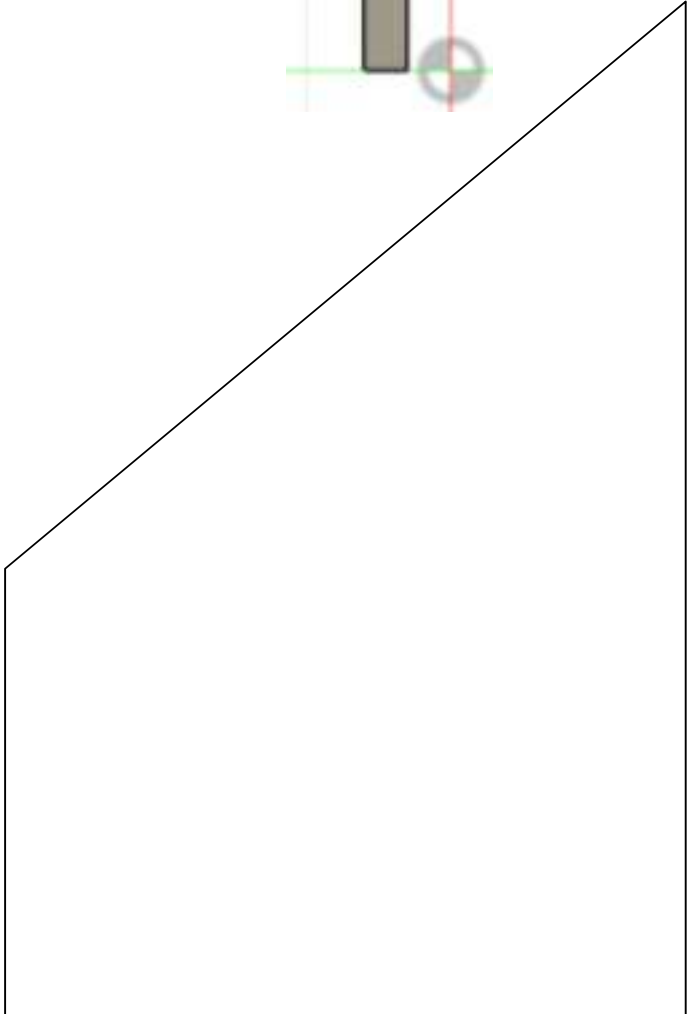

*2

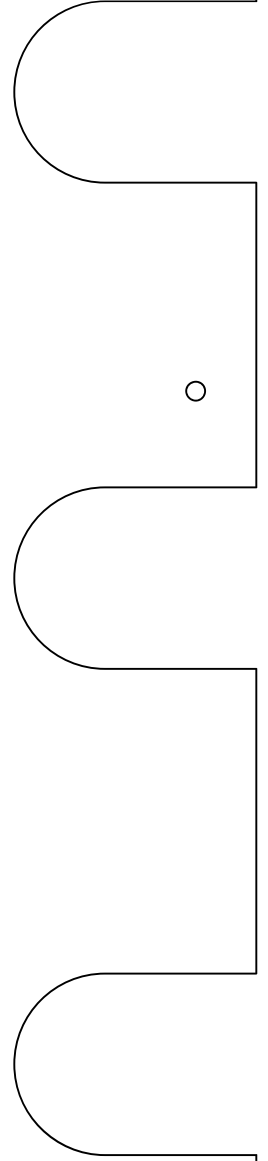

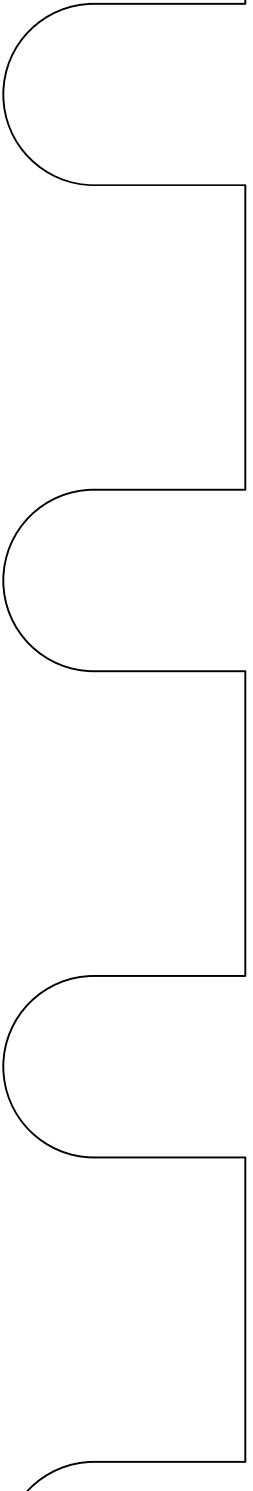
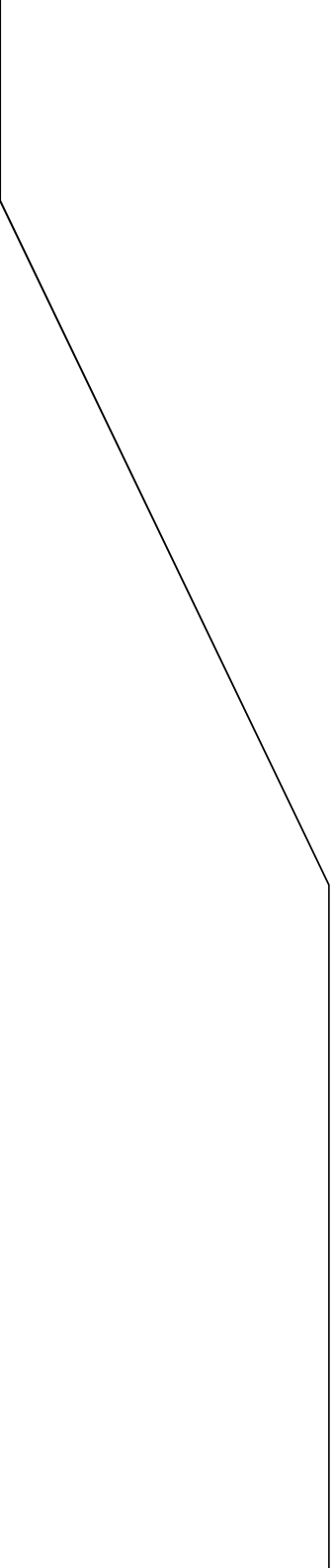

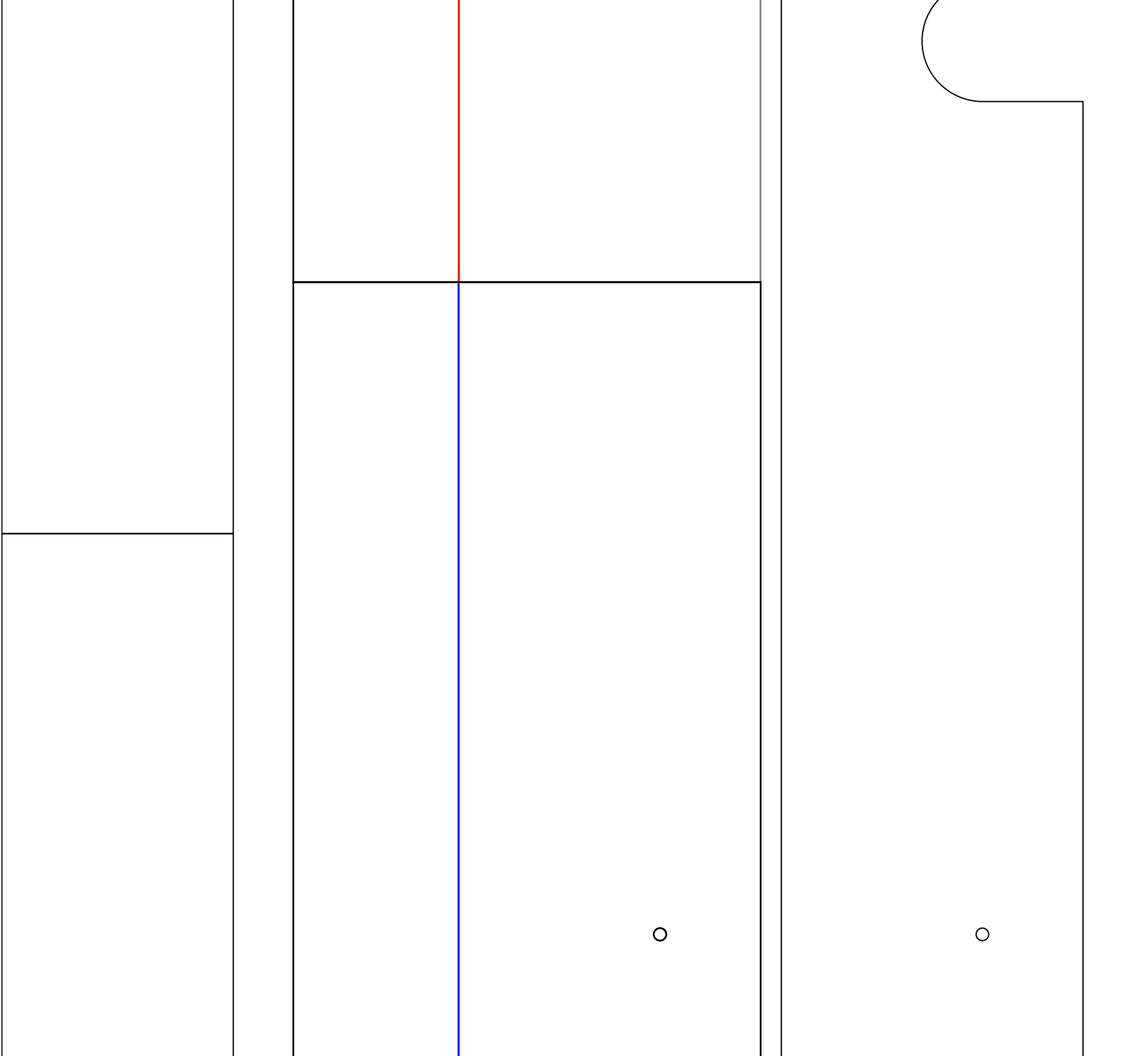

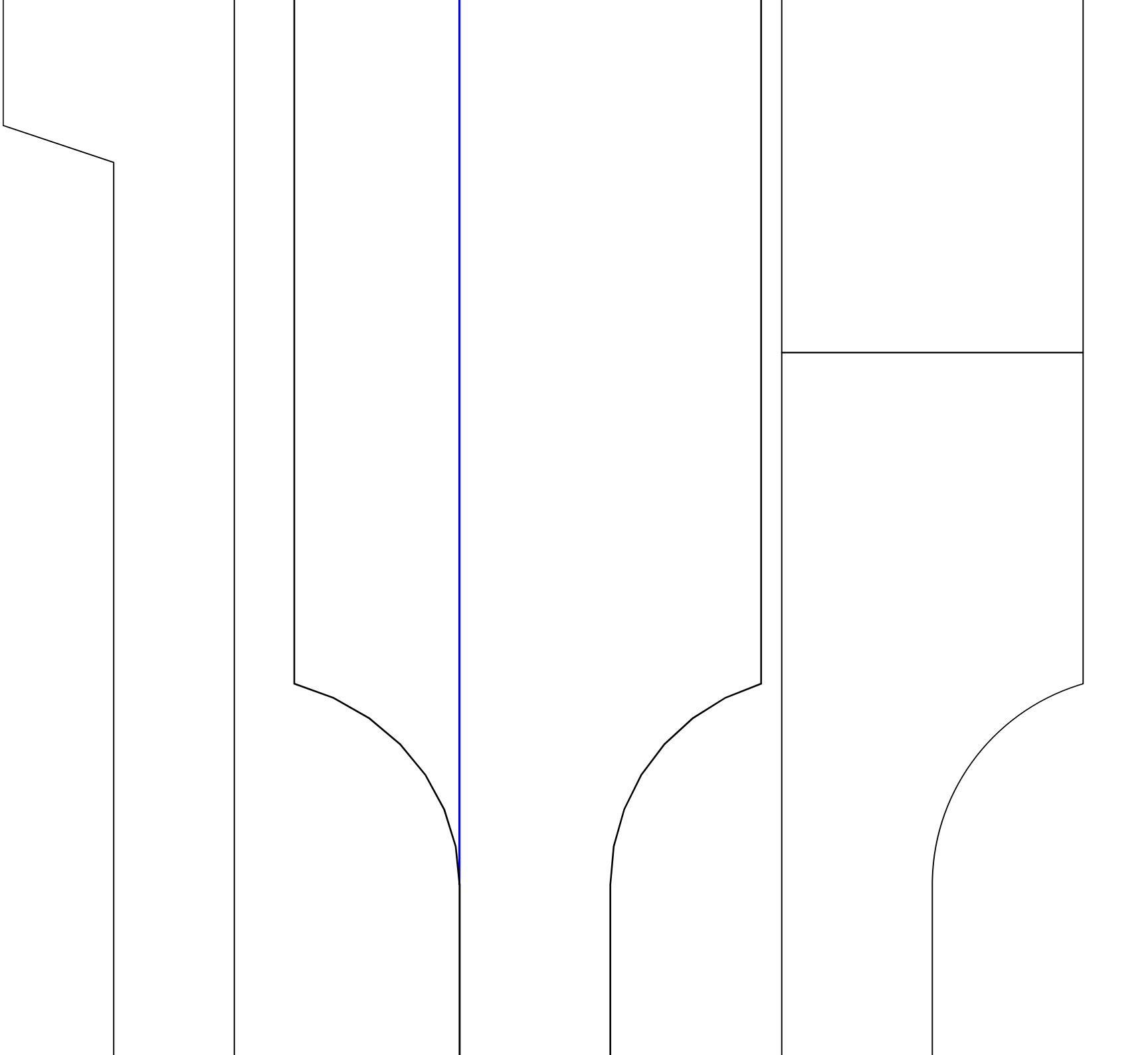

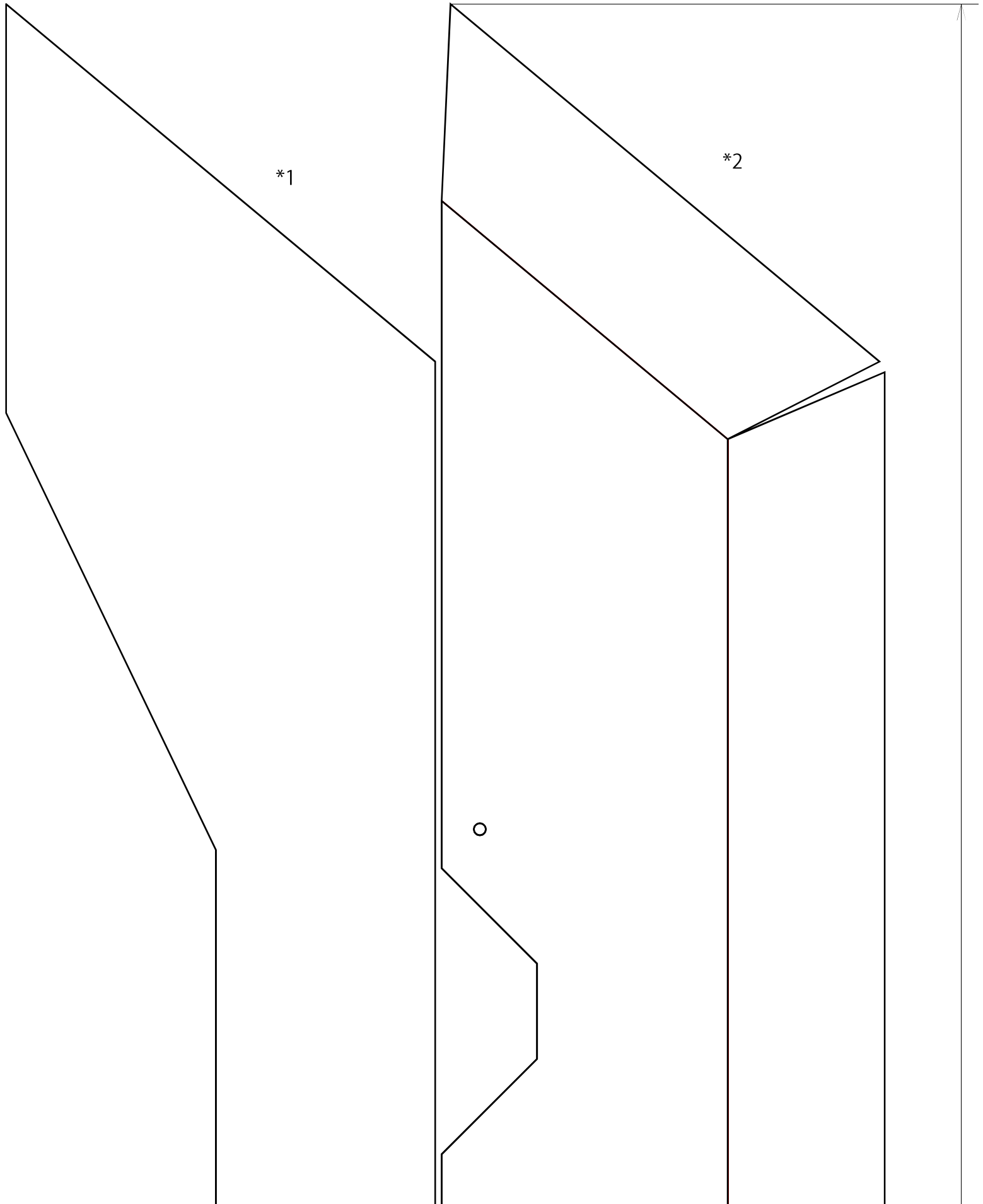

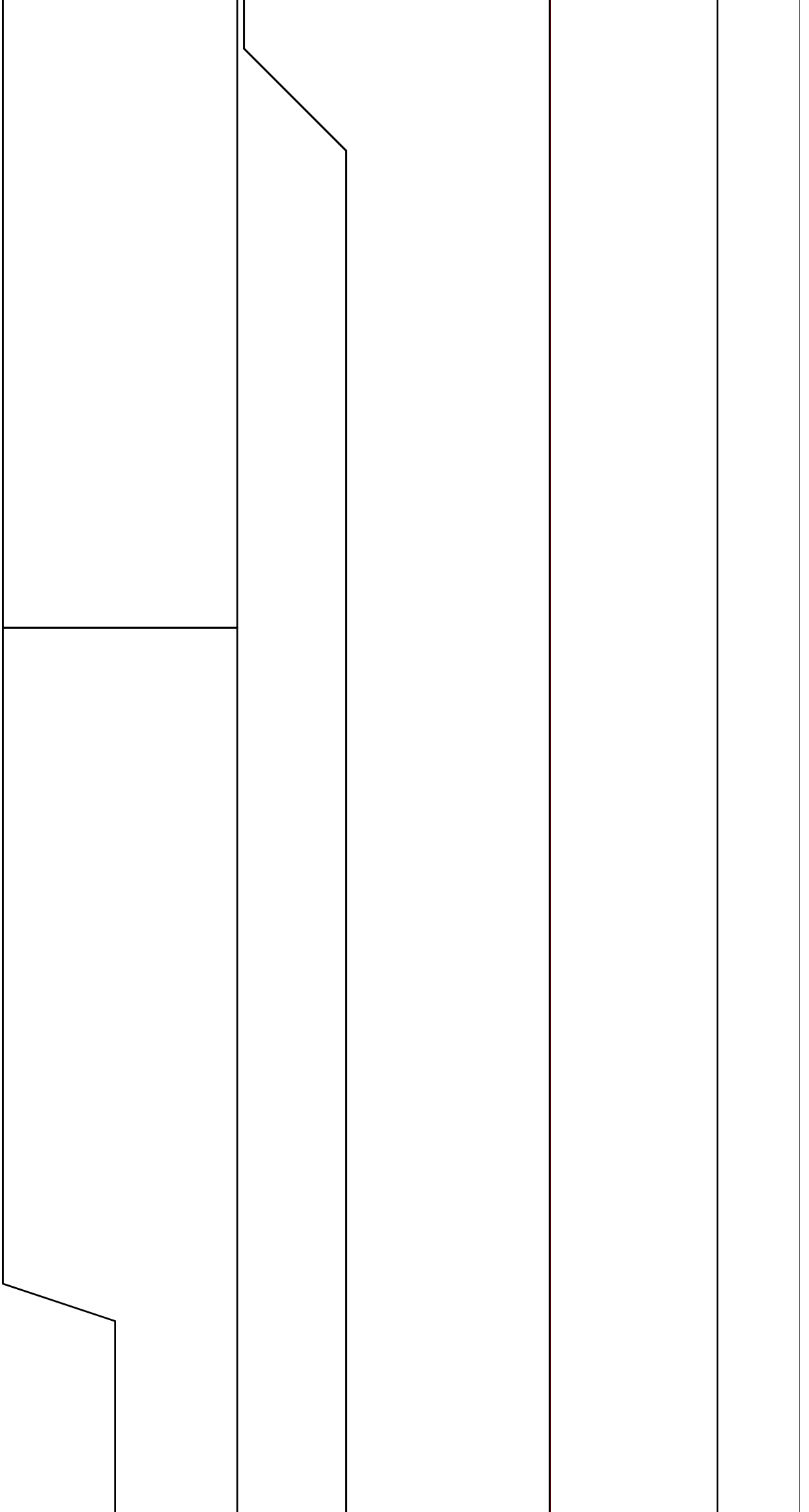

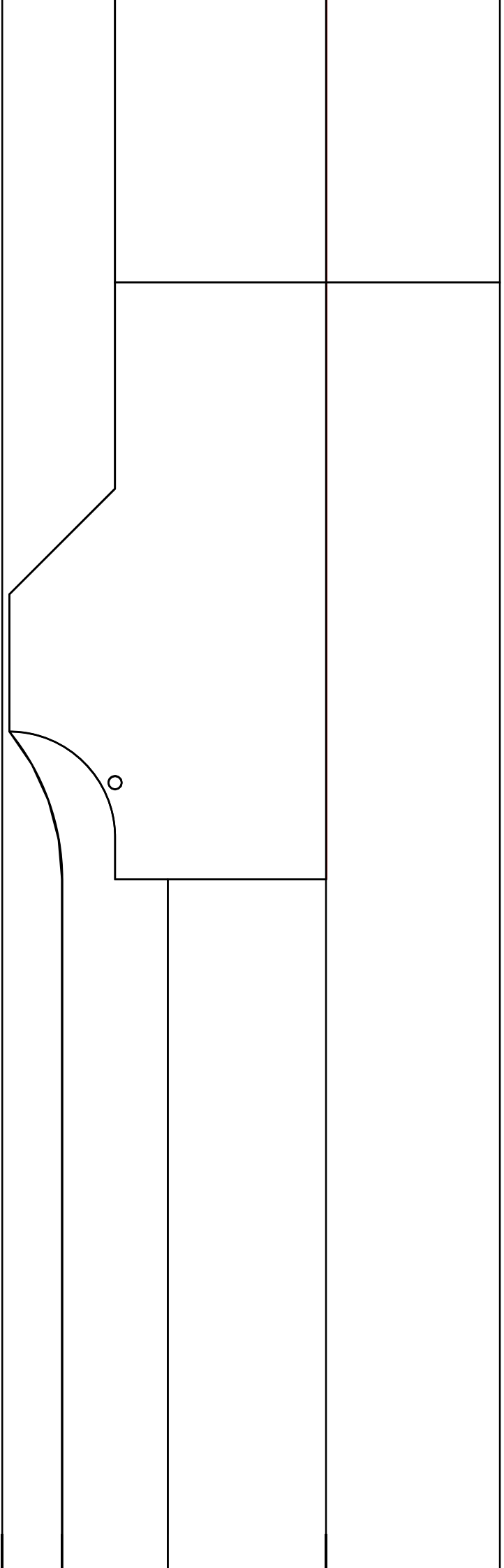
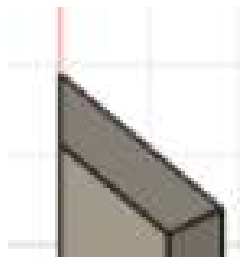

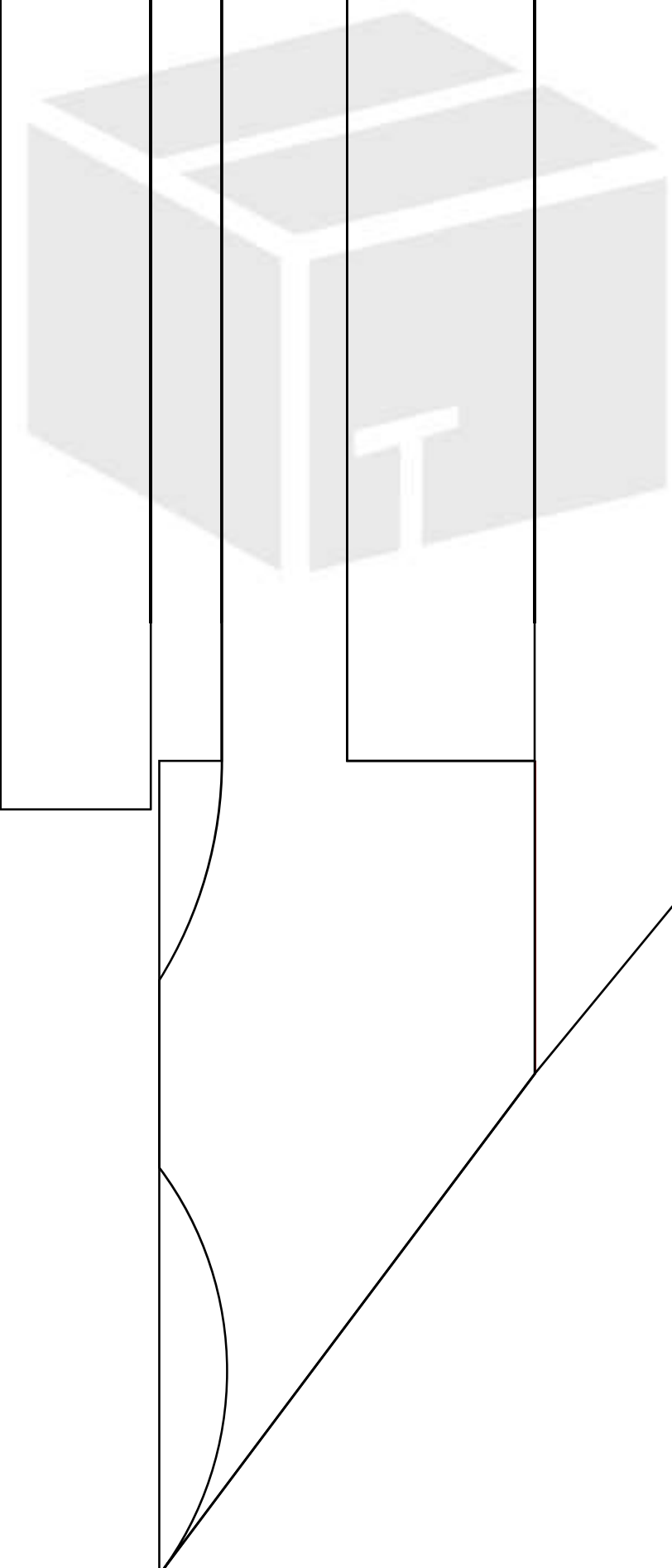
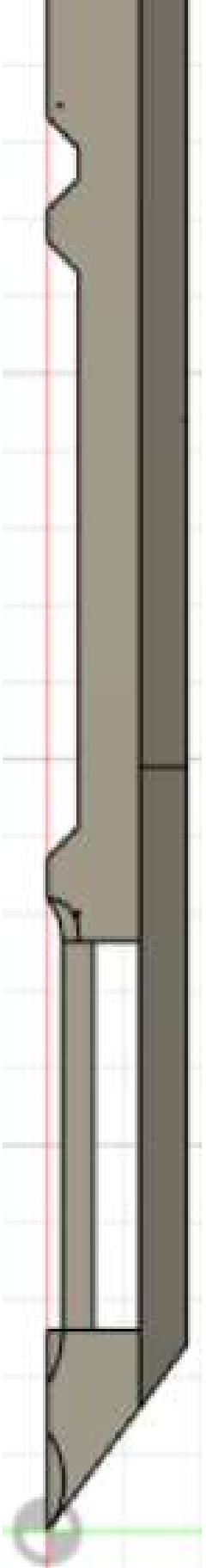

1097 mm

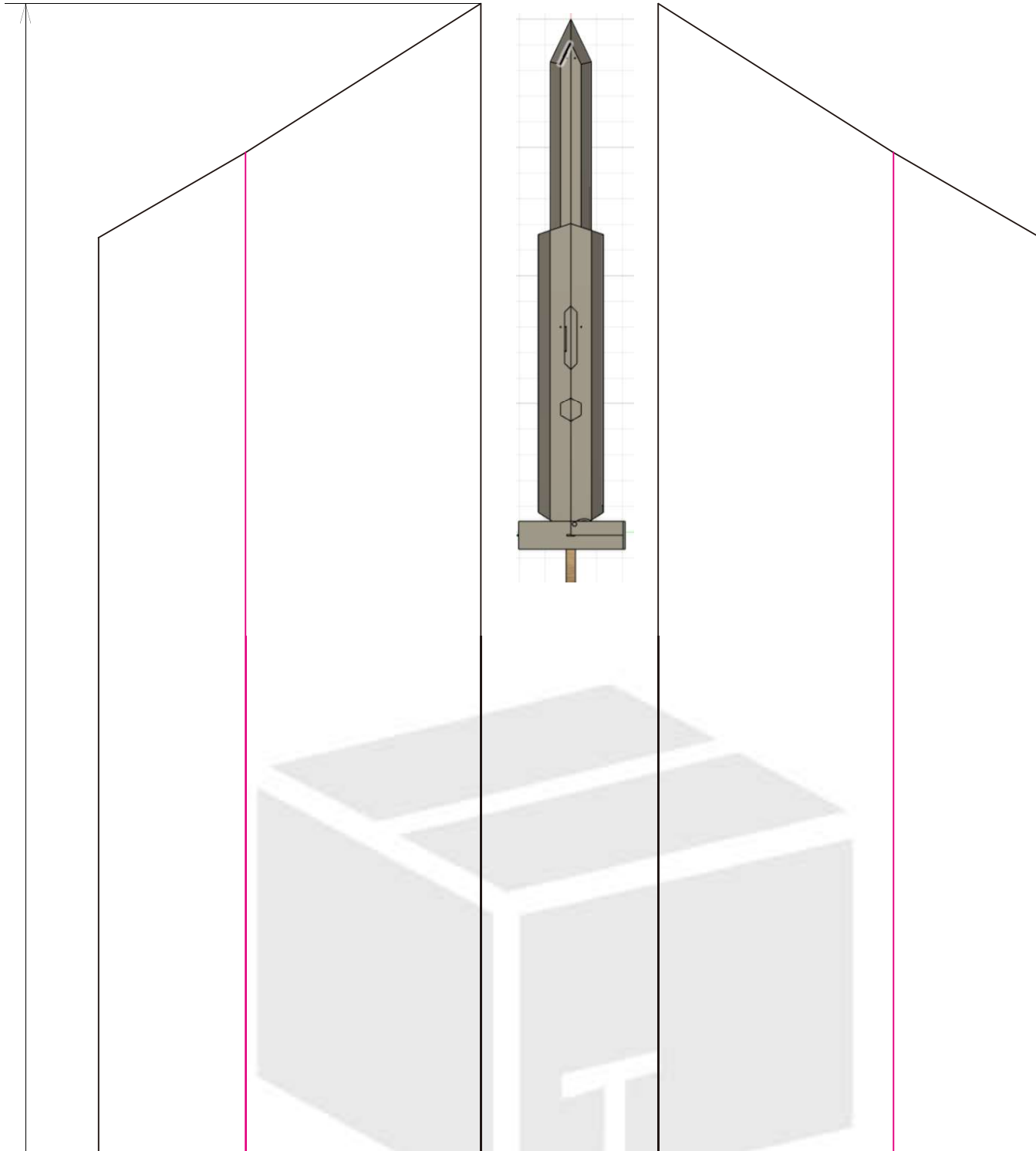

603mm

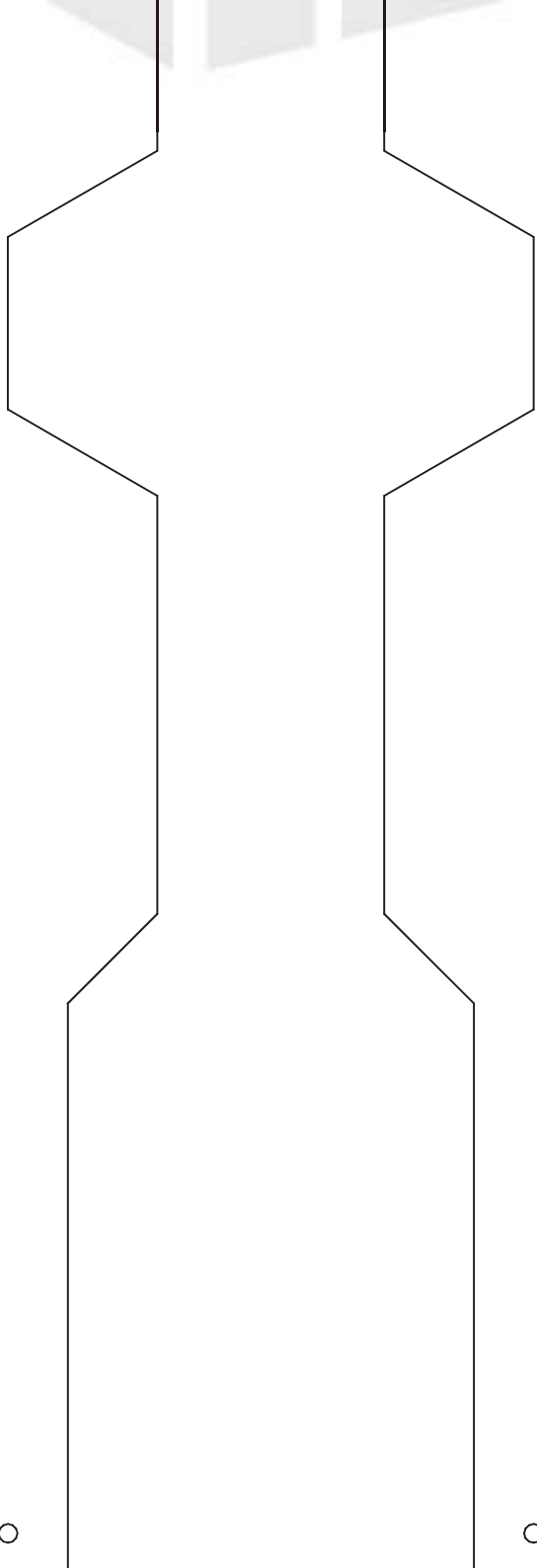

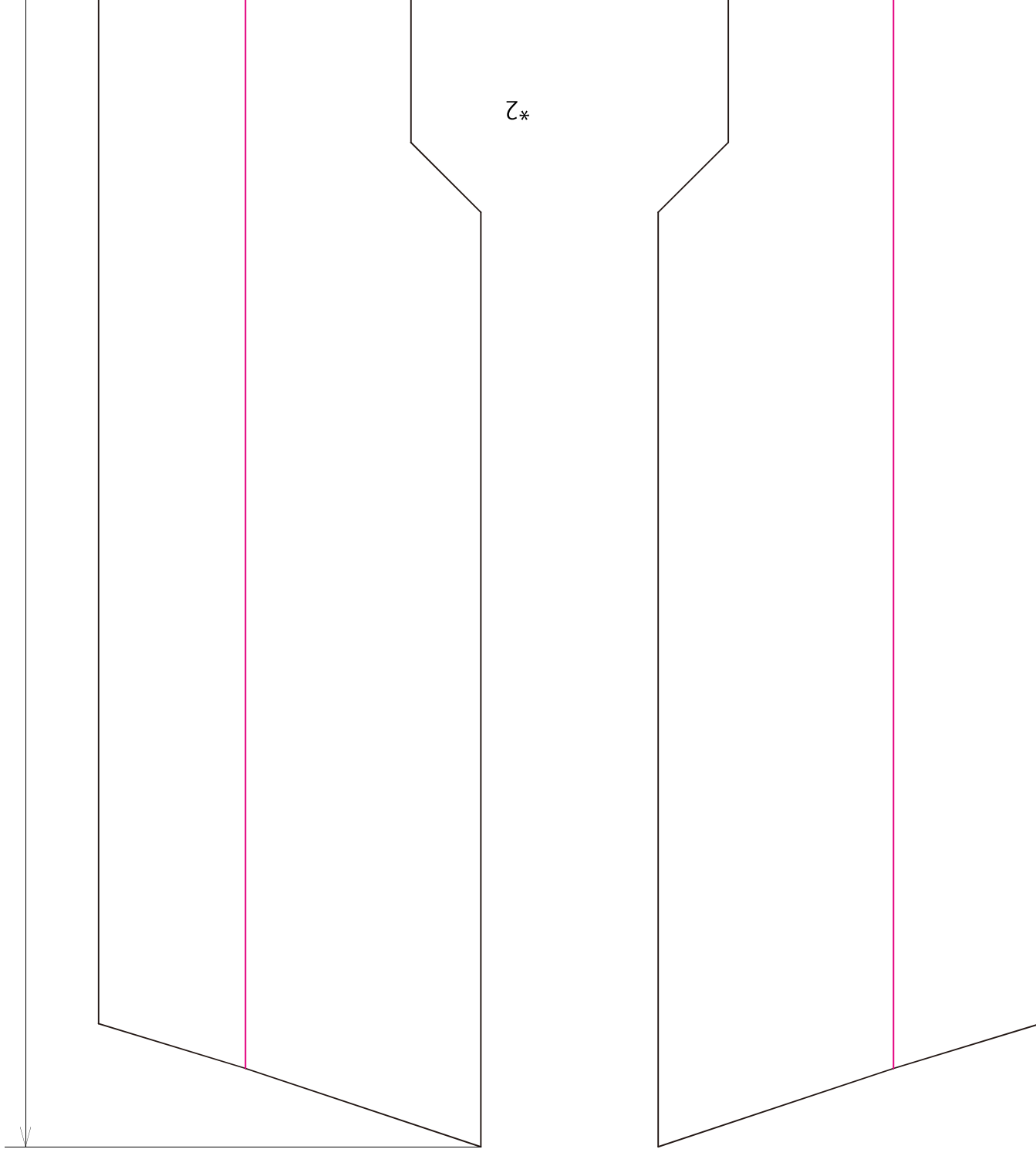

z_*

○

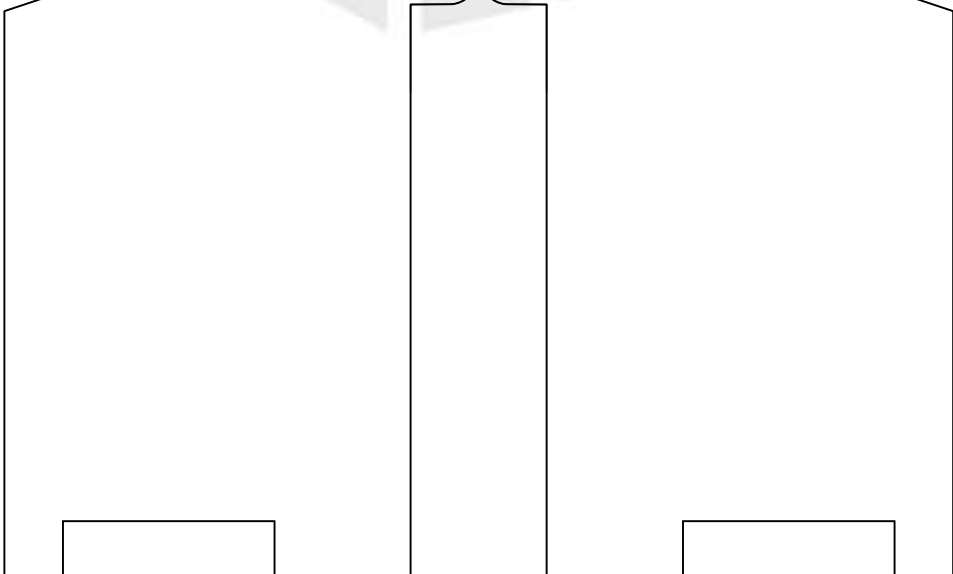
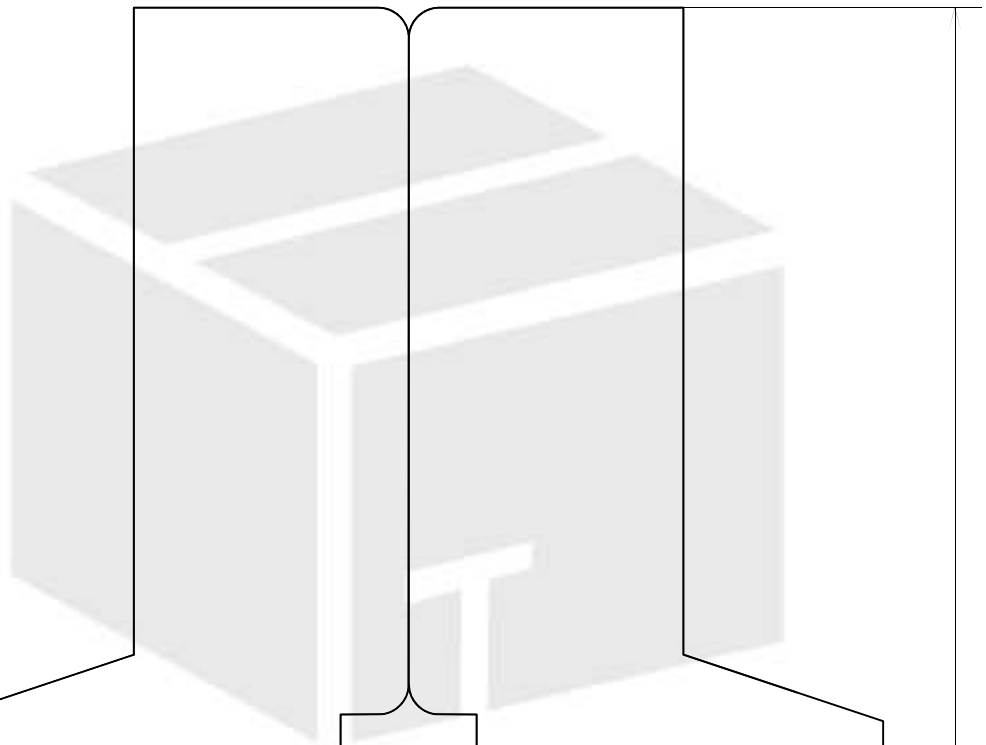
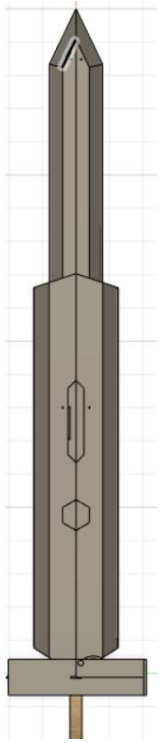



o

*2



o



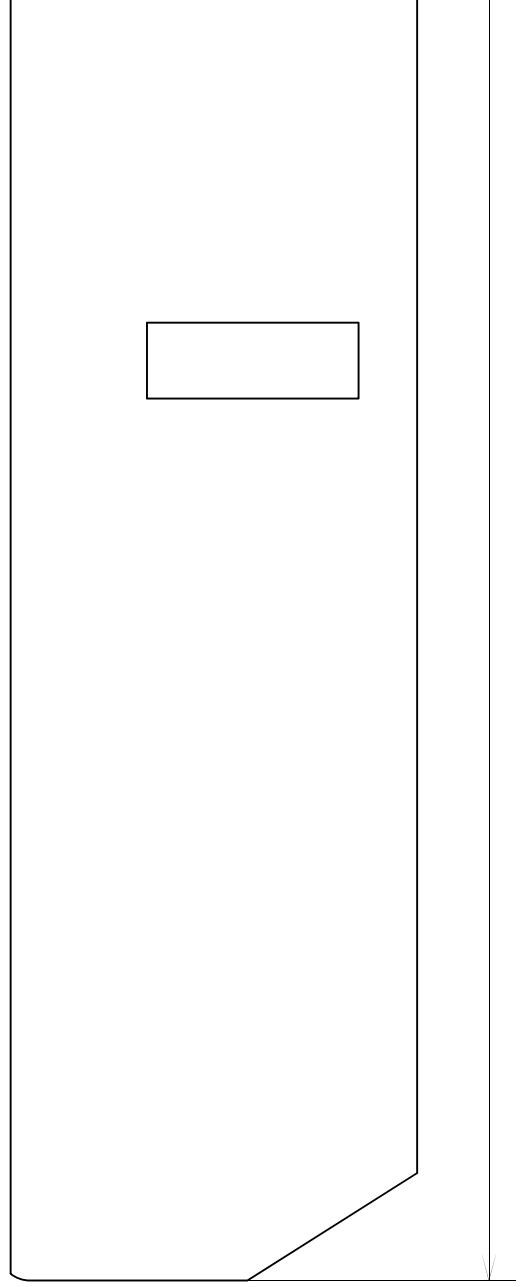
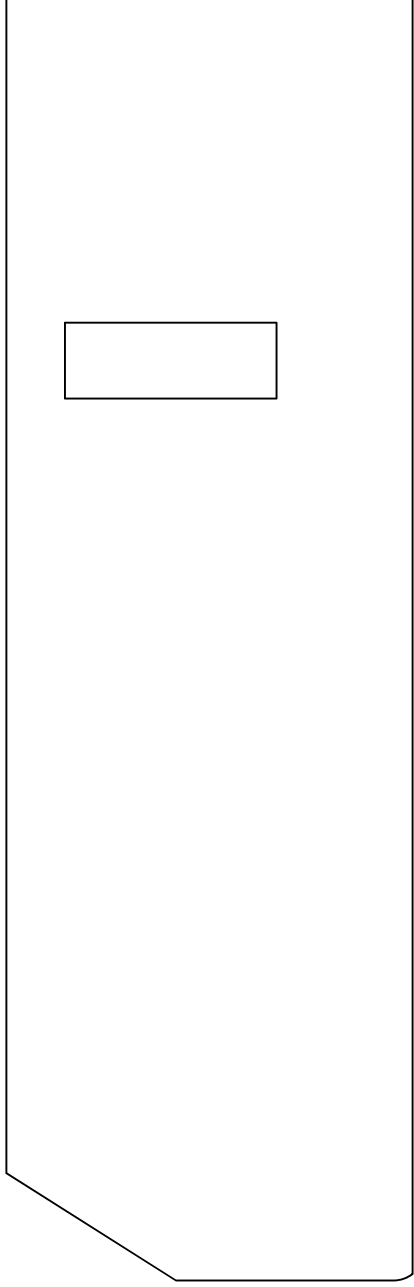

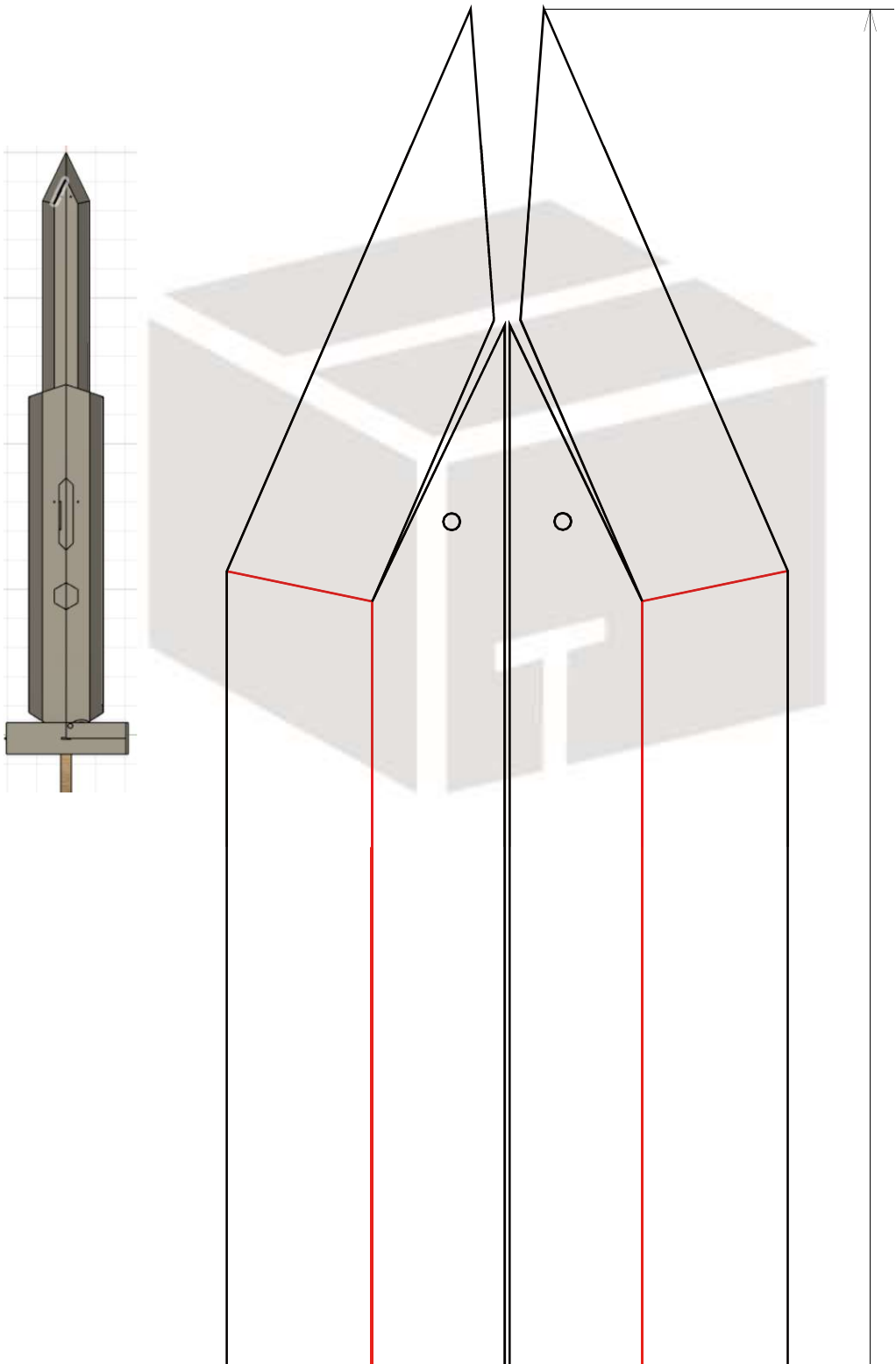

1003

*2

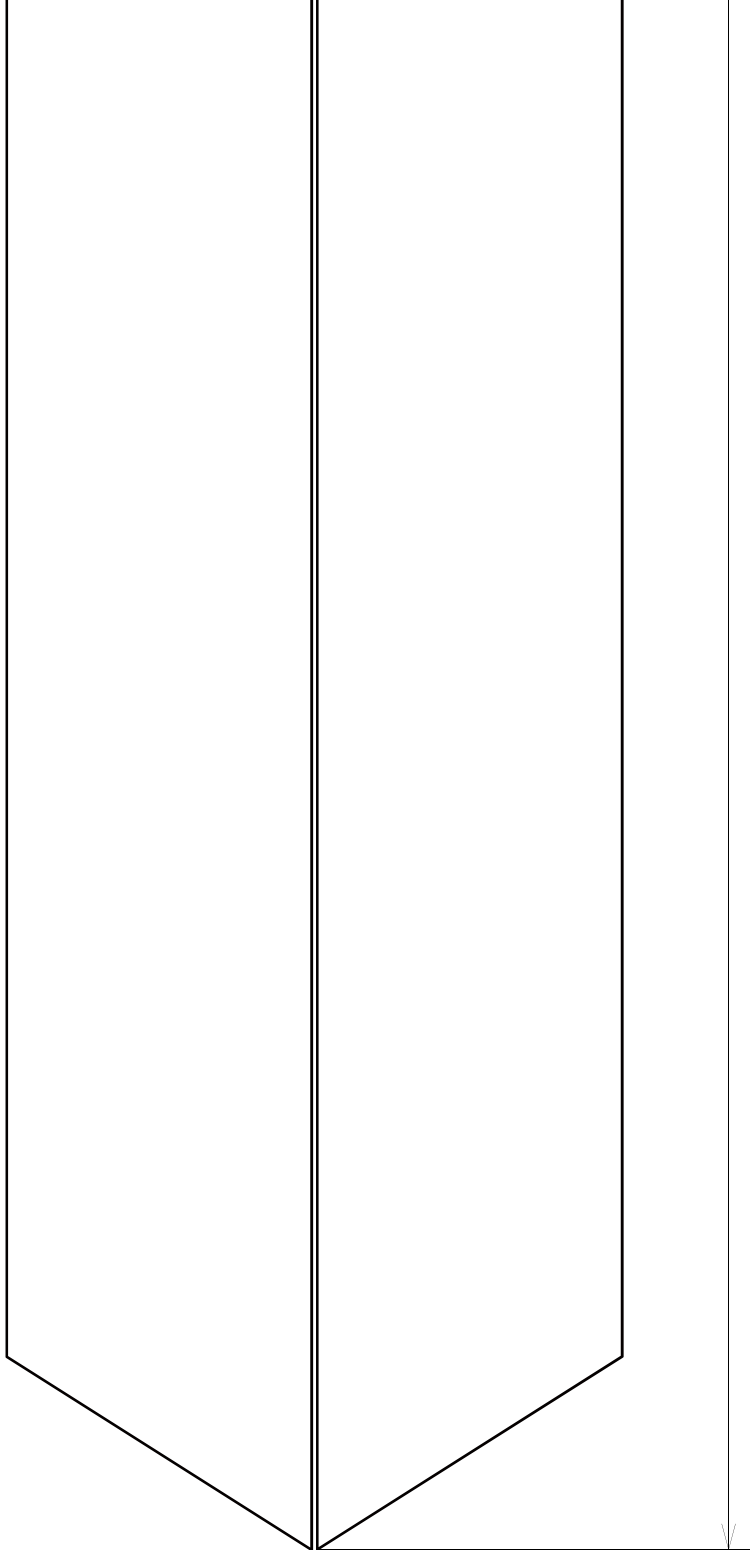

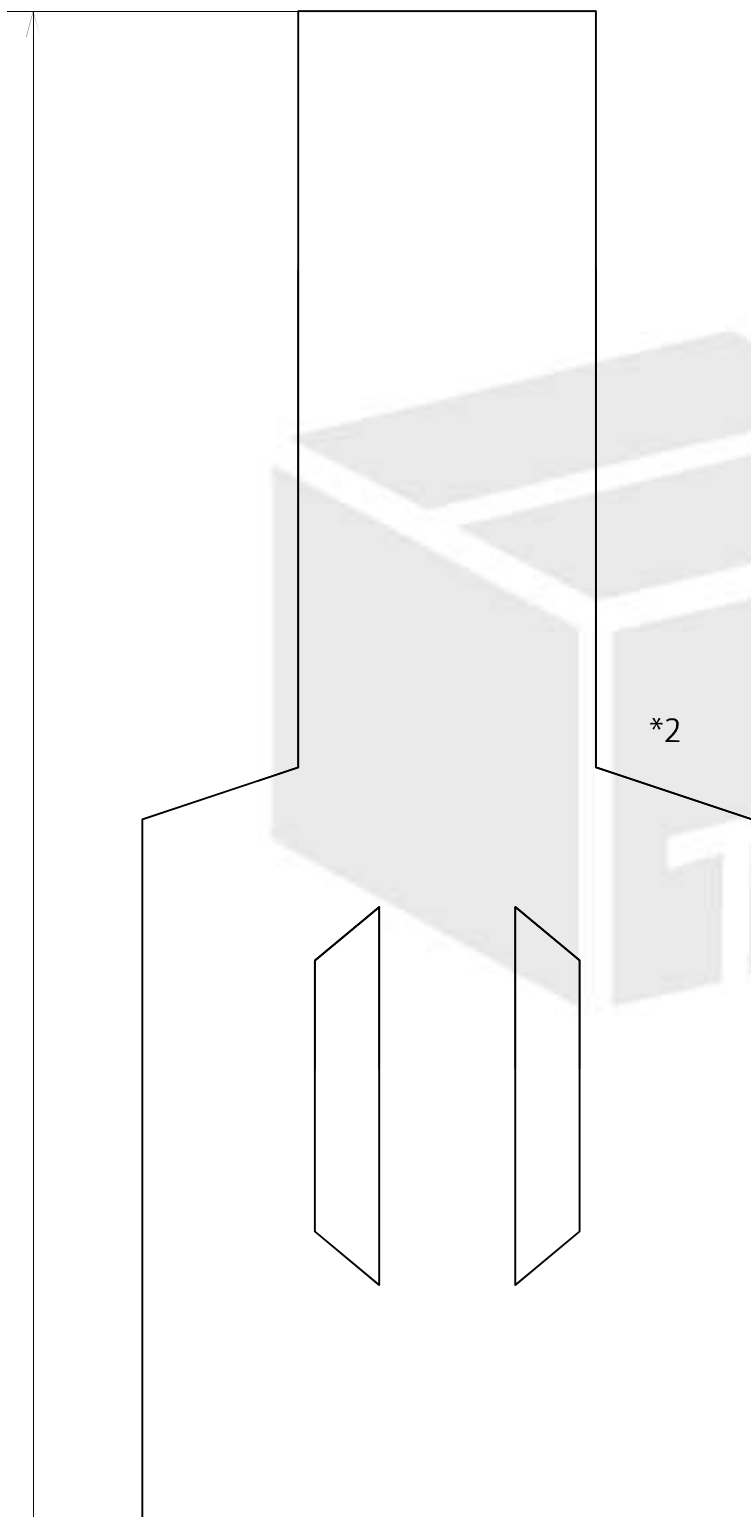

*2

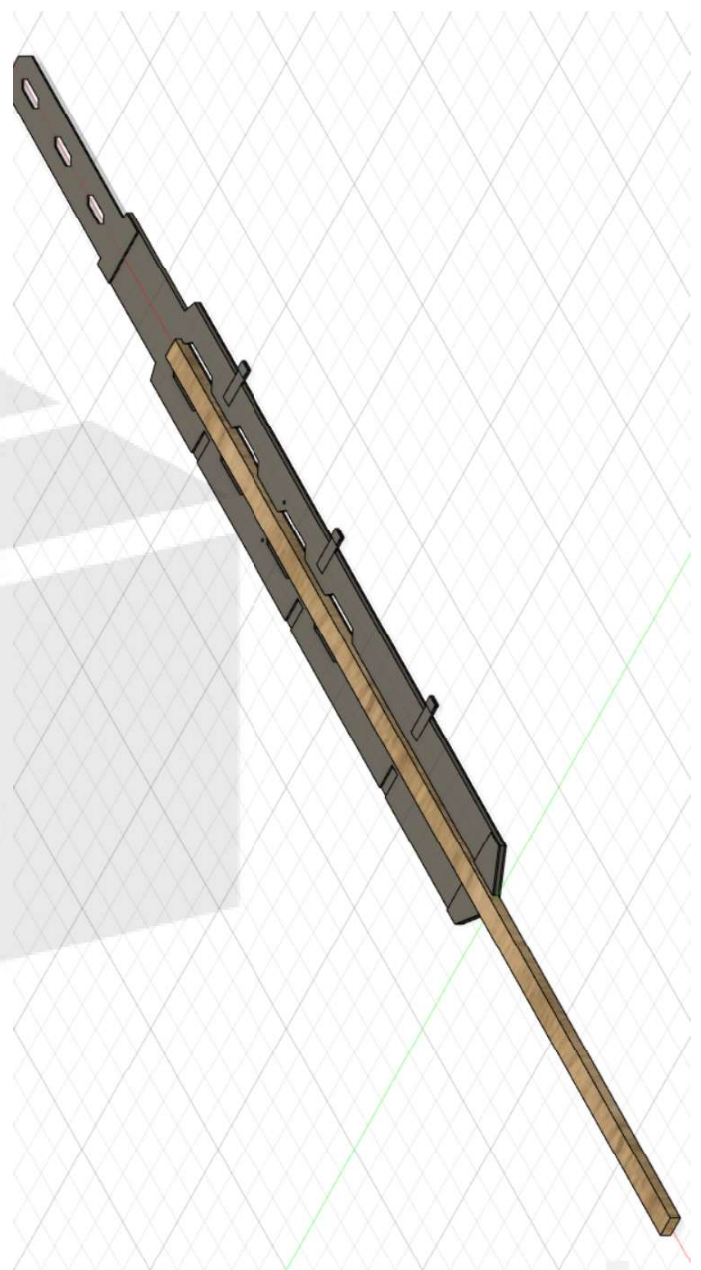

core rod 910*18*9mm

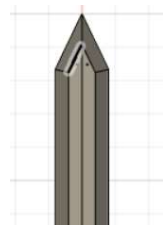

695mm

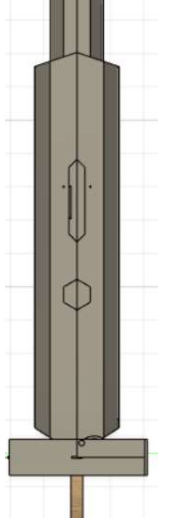
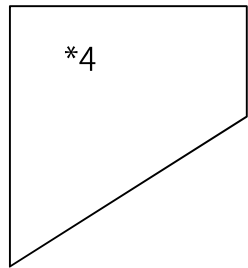
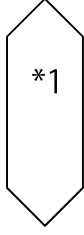
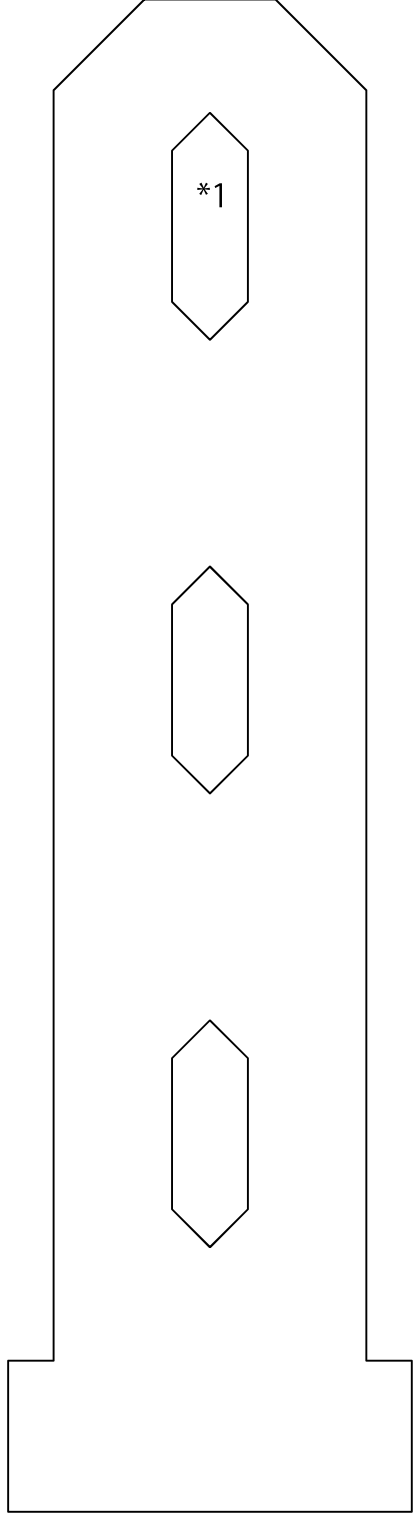
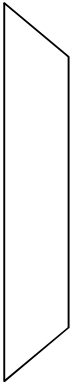
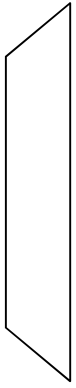
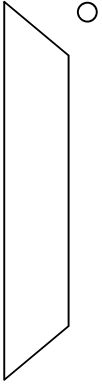
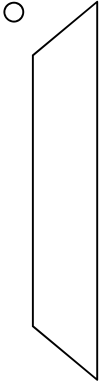
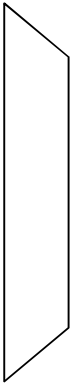
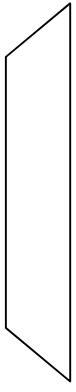

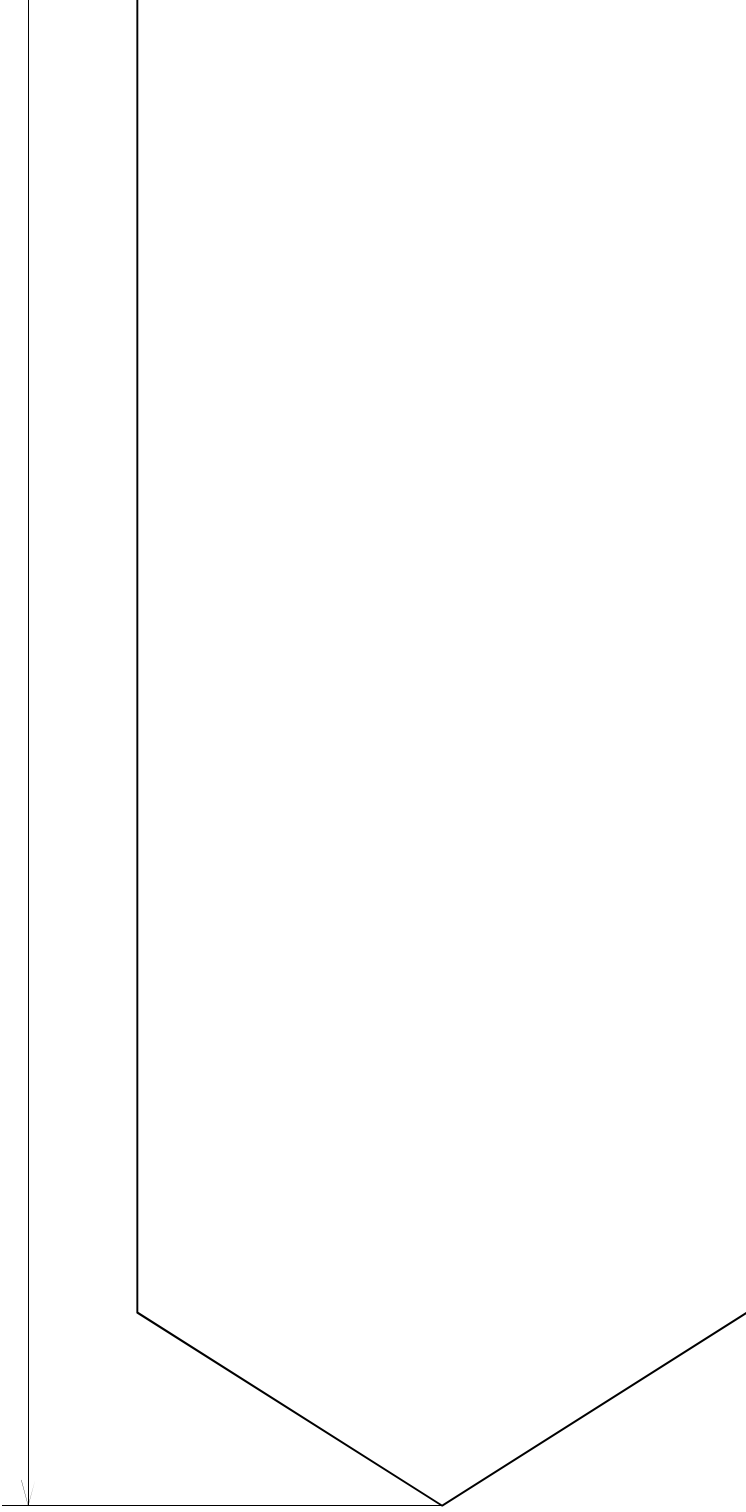

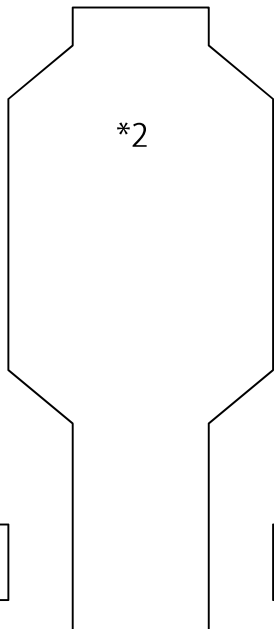
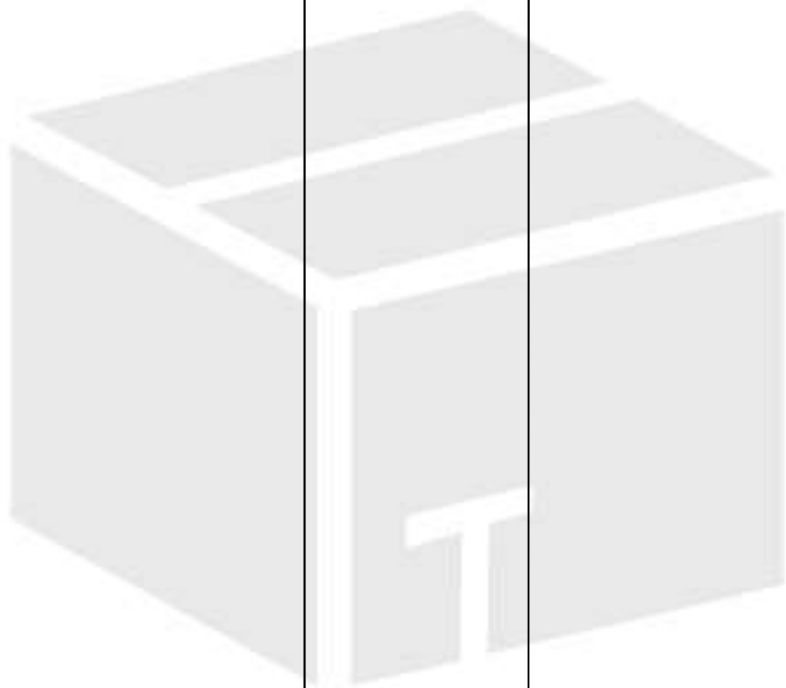
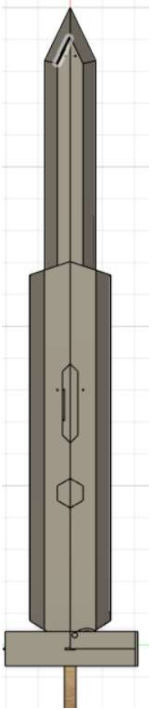

*2

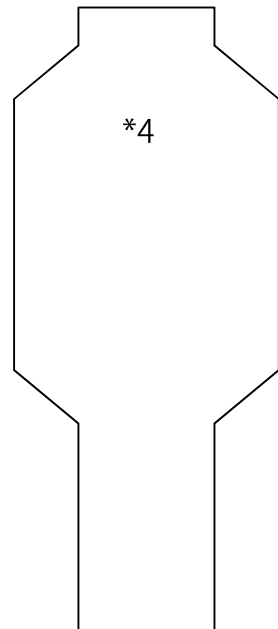

*4

690mm

*6

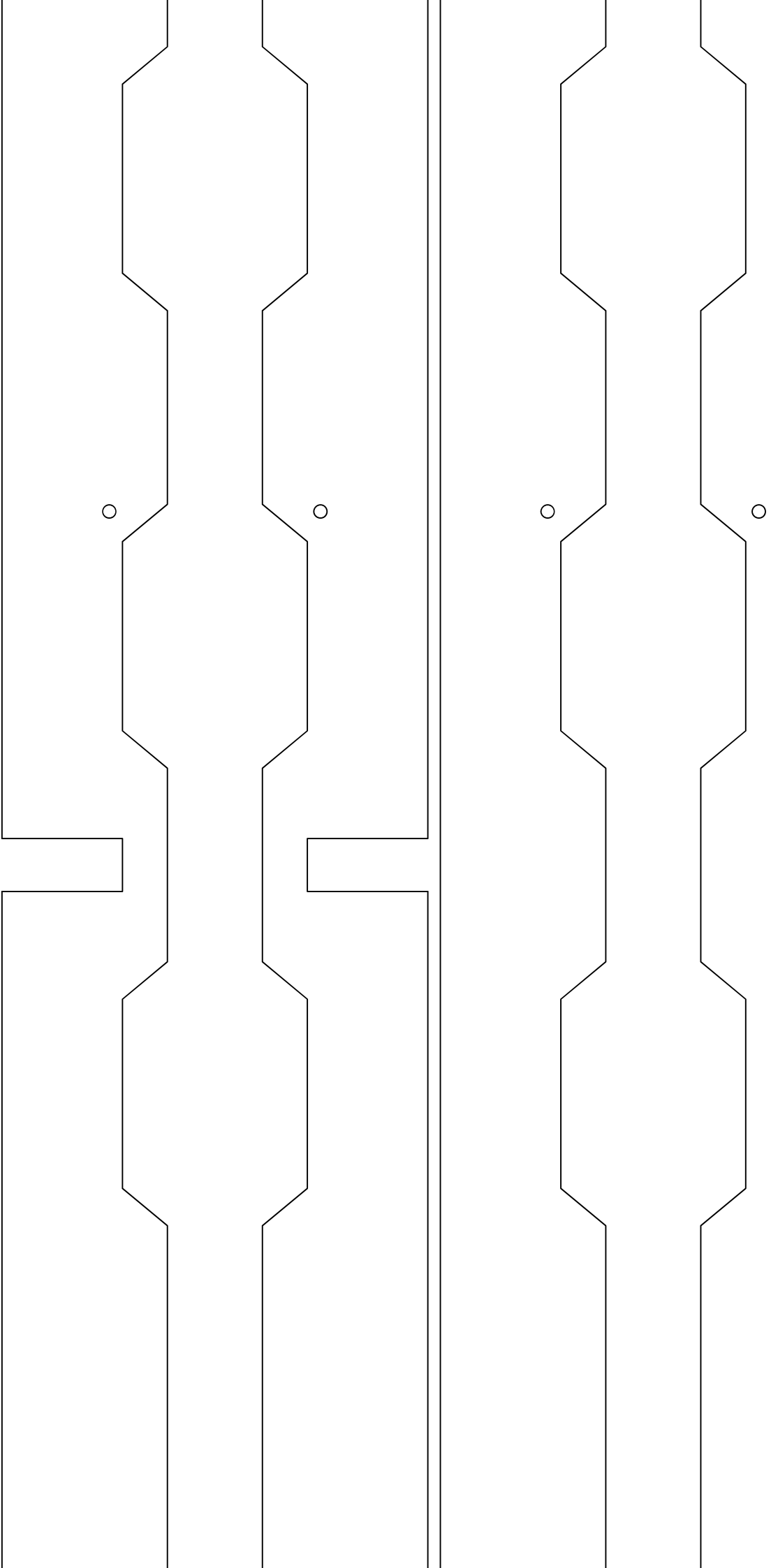

wood plates

