

105BL

105AL^{0.5}

99L

99P 106L

97P

108L

98P

Rozciąć do kropki

98AP

278b

99a

105L

112L

52g

120AL

99a

99a

97AP

Rozciąć do kropki

109AL

Pk7L

Pk7P

95P

80b

109L

PH1BA

278a

80a^B

278

80d^B

80^B

80c^B

Pk7cP

Pk7bP

Pk7aP

Pk7cL

Pk7bL

Pk7aL

111L

96P

Rozciąć do kropki

100AP

Rozciąć do kropki

104L

94P

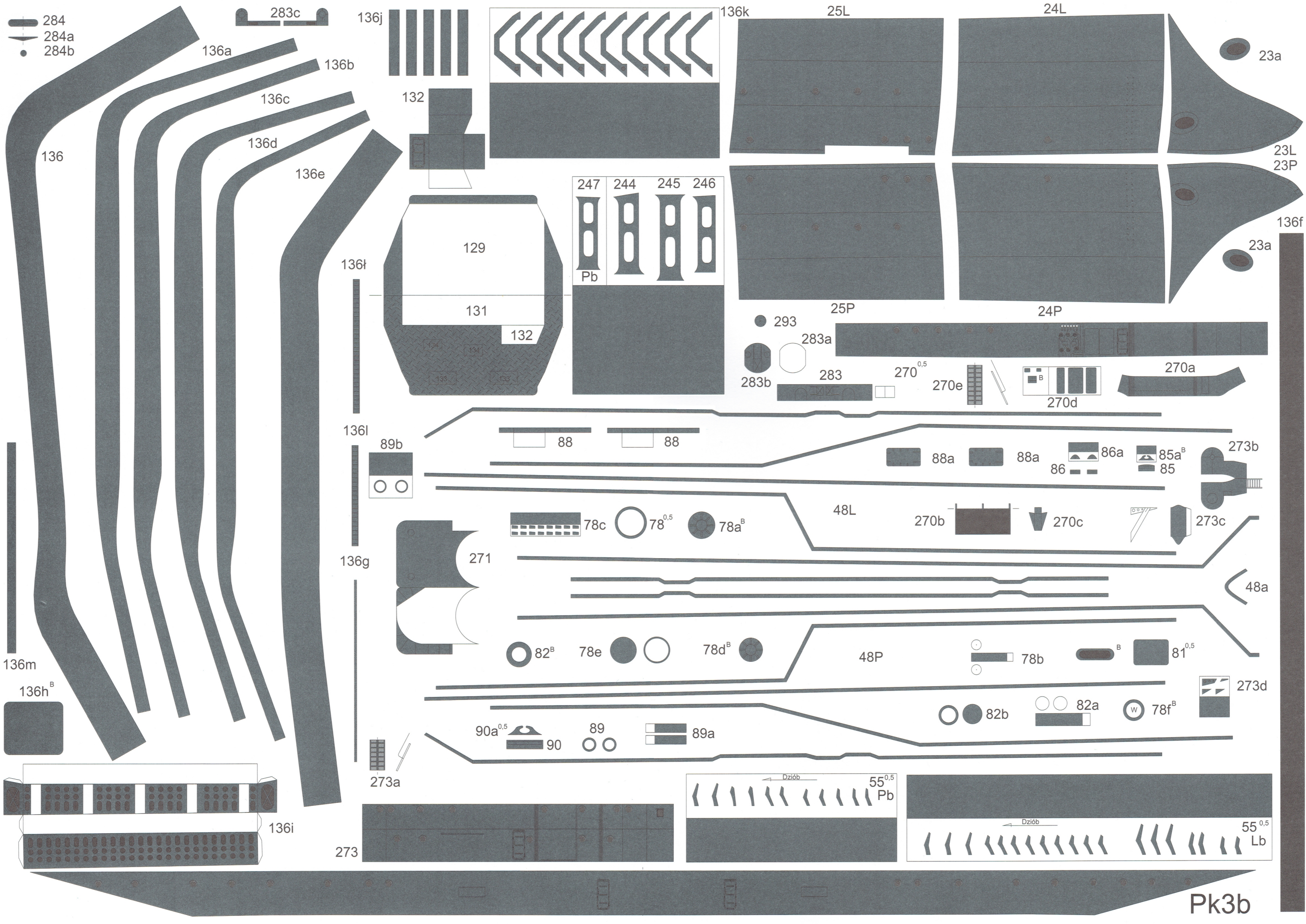

Pk3b

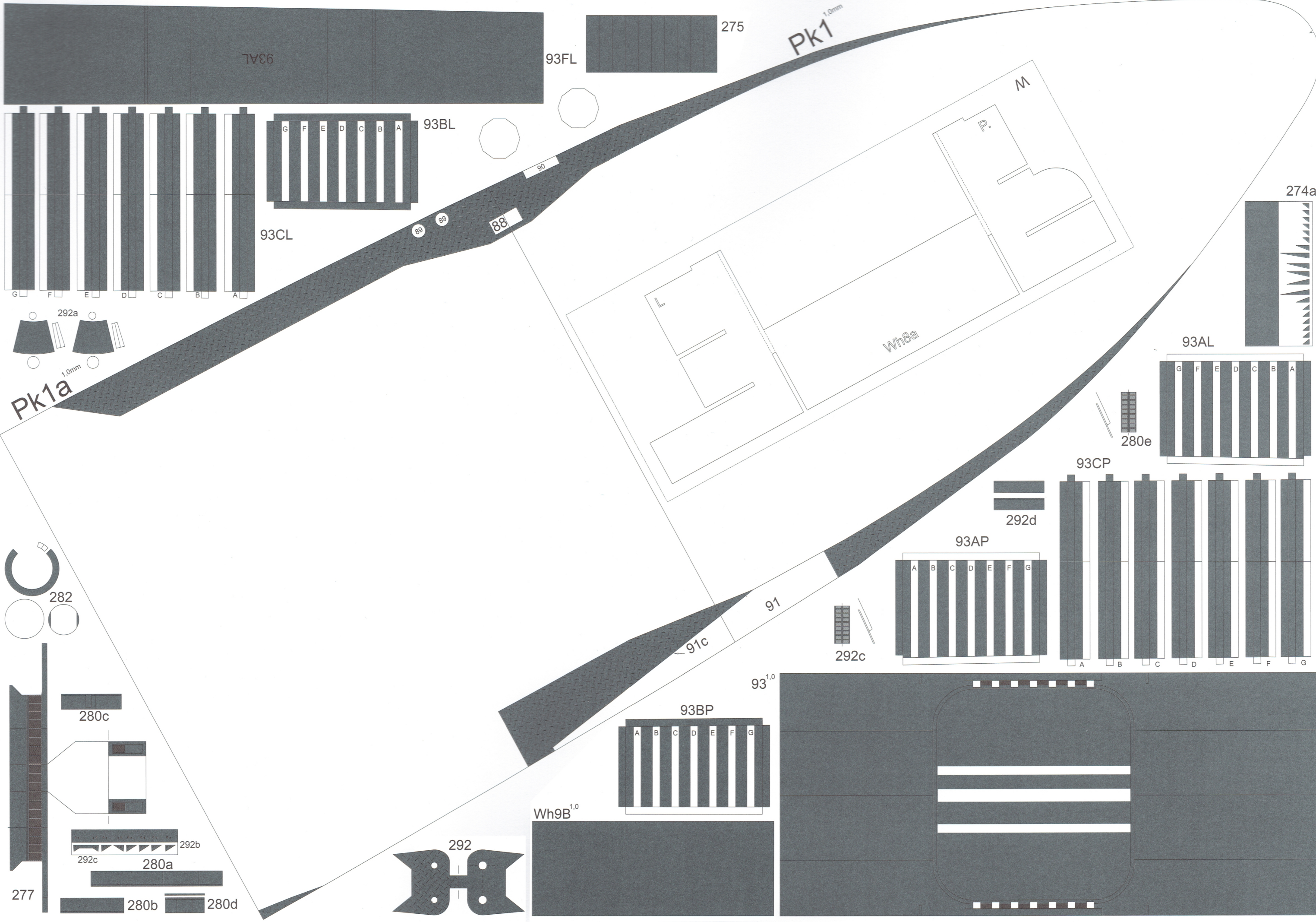

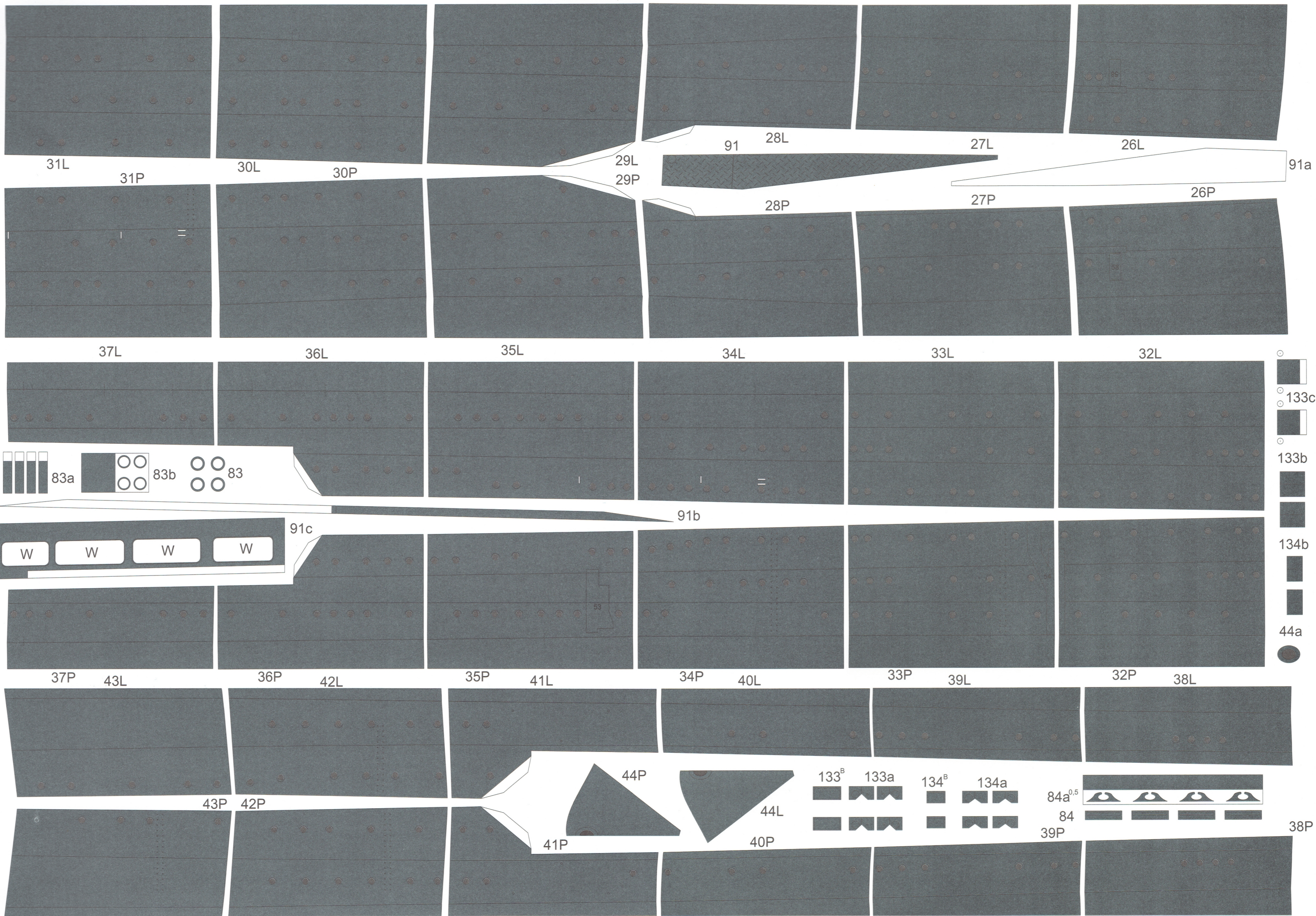

31L

31P

30L

30P

29L

29P

91

28L

27L

26L

91a

28P

27P

26P

37L

36L

35L

34L

33L

32L

83a

83b

83

91b

91c

W

W

W

W

37P

43L

36P

42L

35P

41L

34P

40L

33P

39L

32P

38L

43P

42P

44P

41P

44L

40L

40P

133^B

133a

134^B

134a

84a^{0.5}

84

39P

38P

- 133c
- 133b
- 134b
- 44a

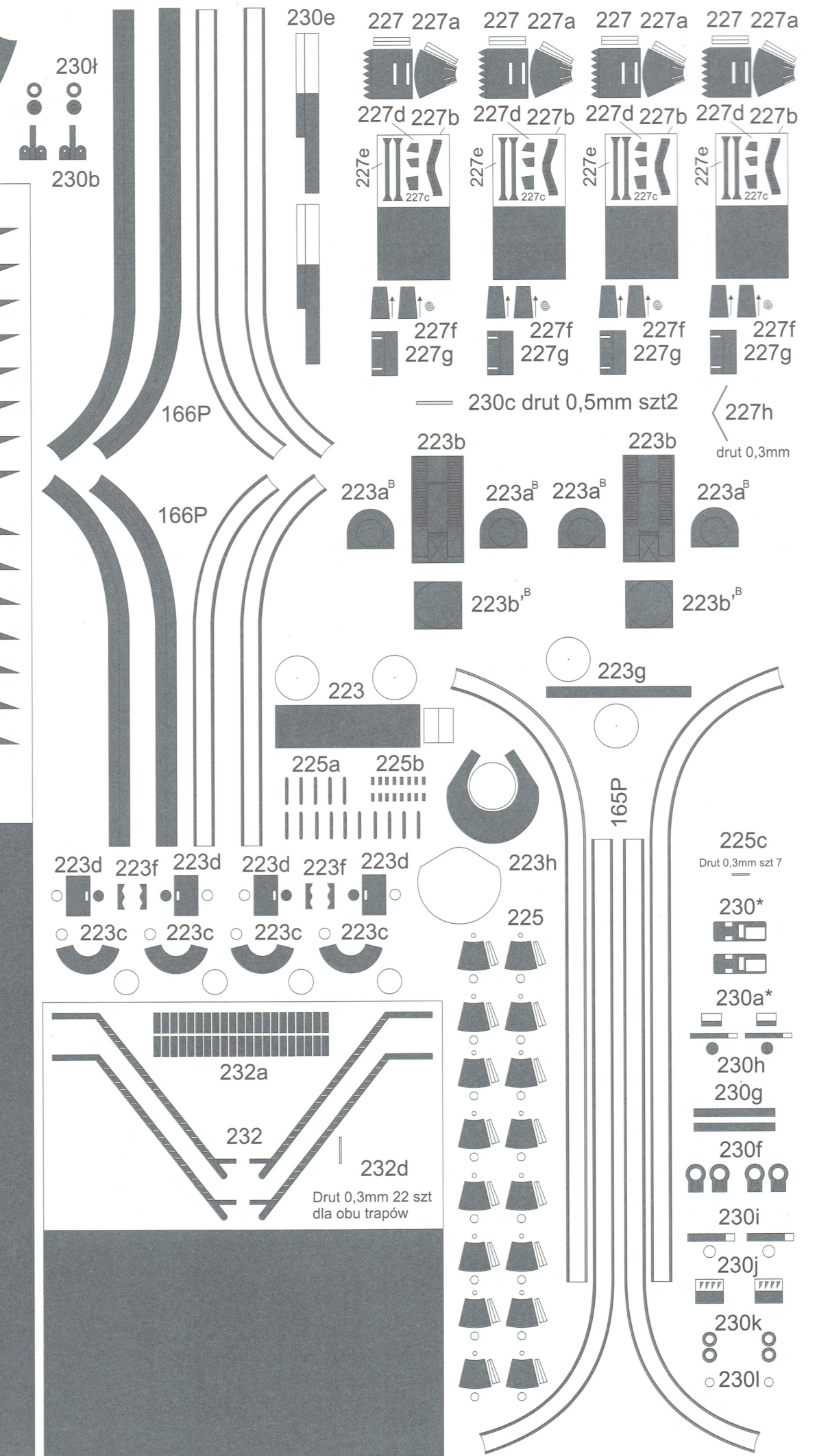
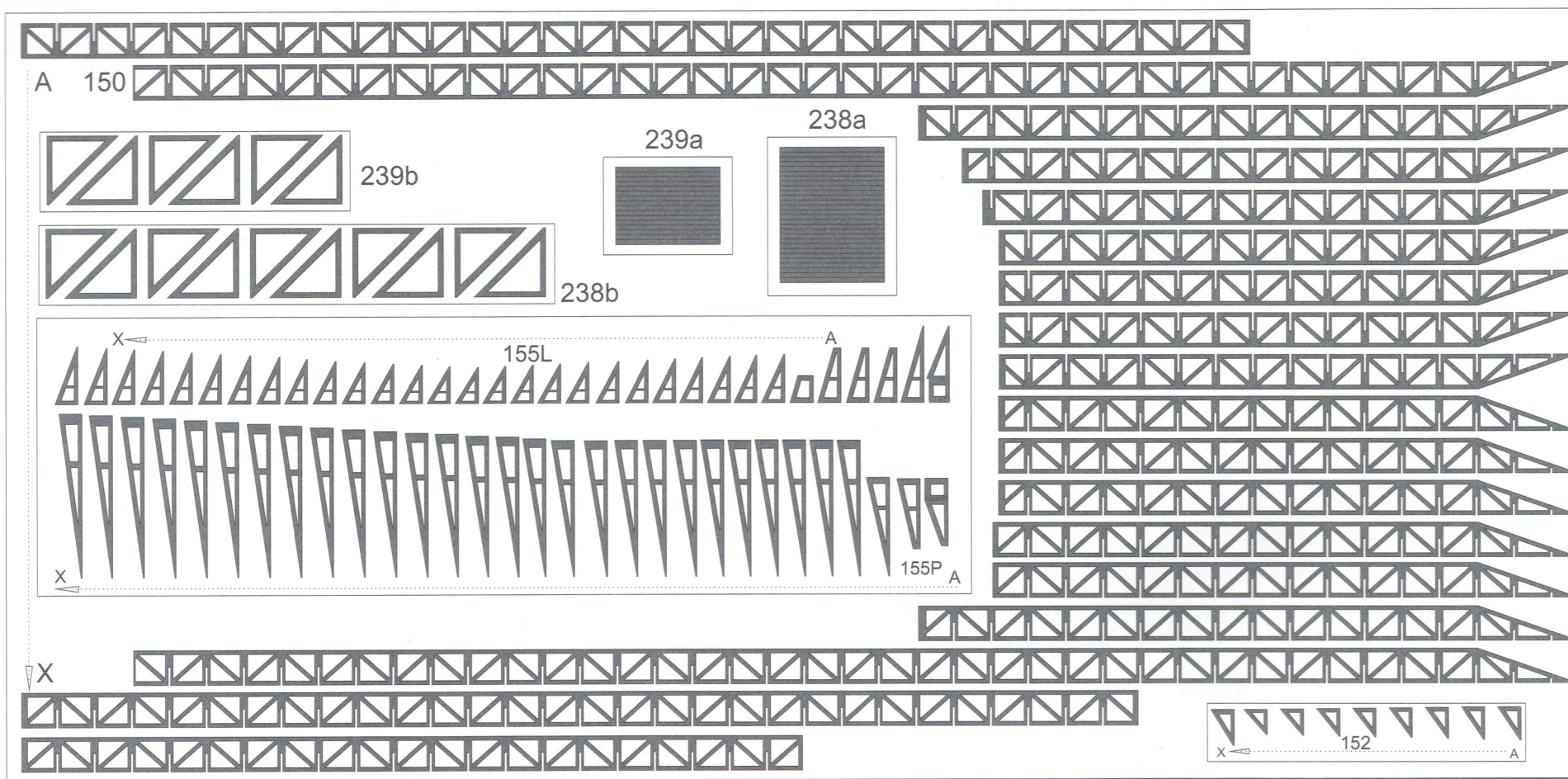
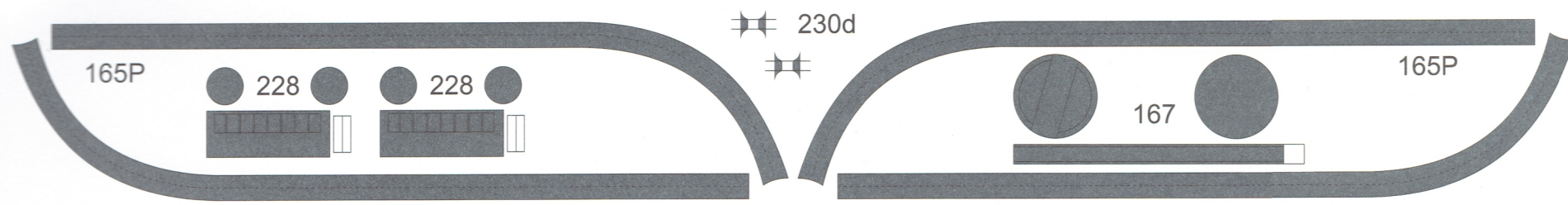

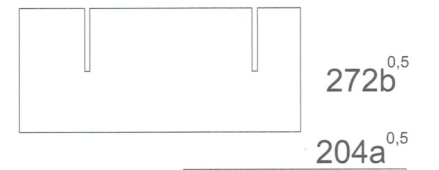
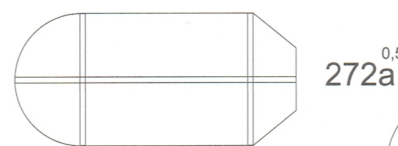
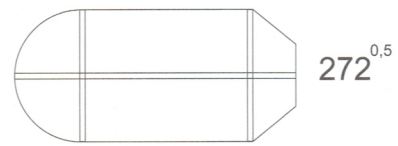
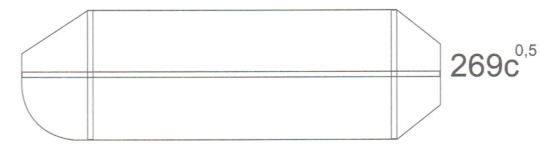
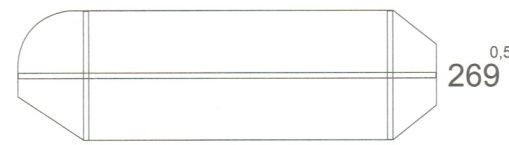
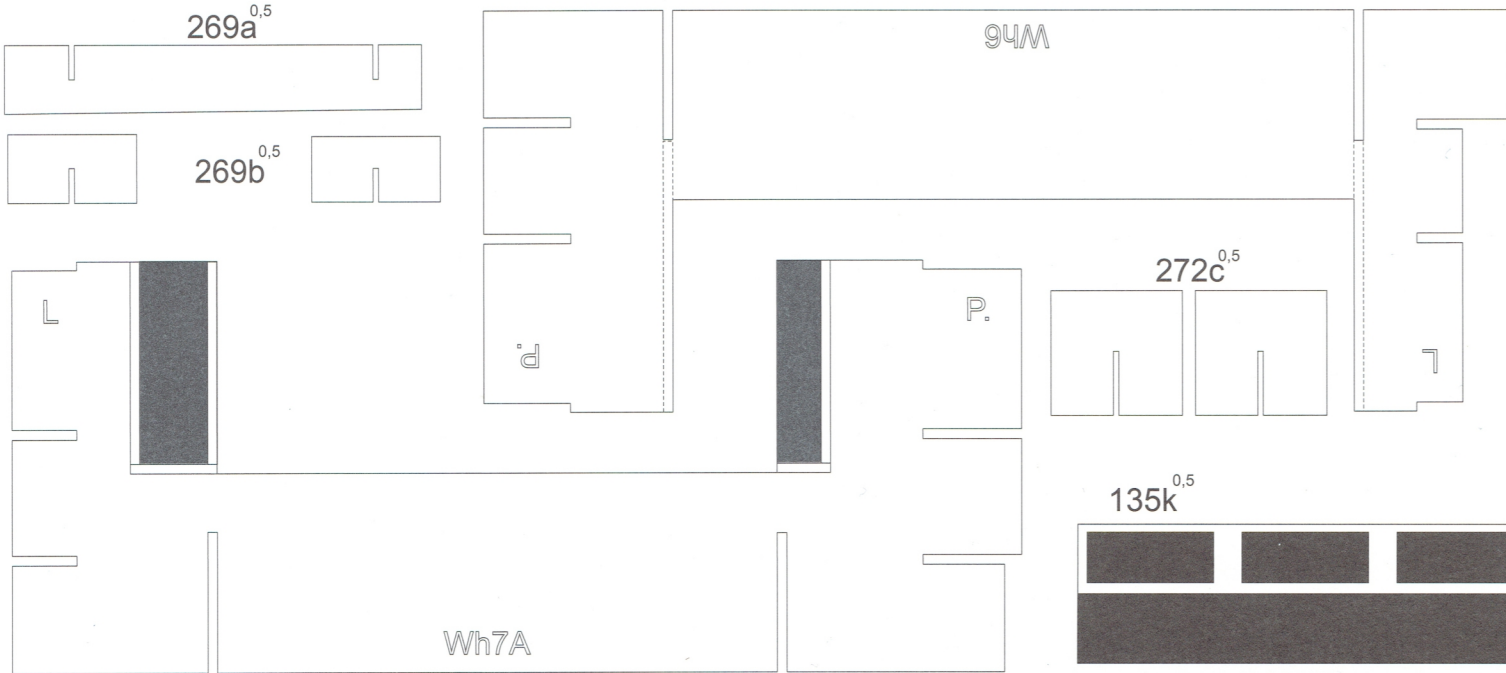
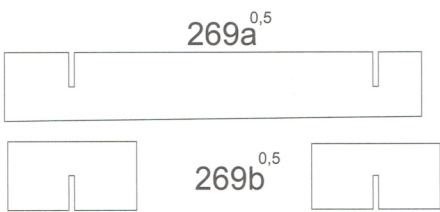
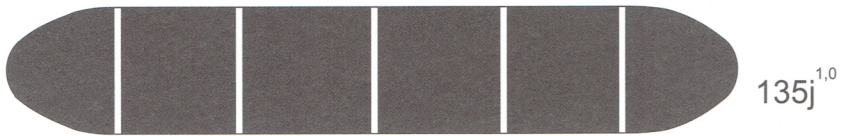
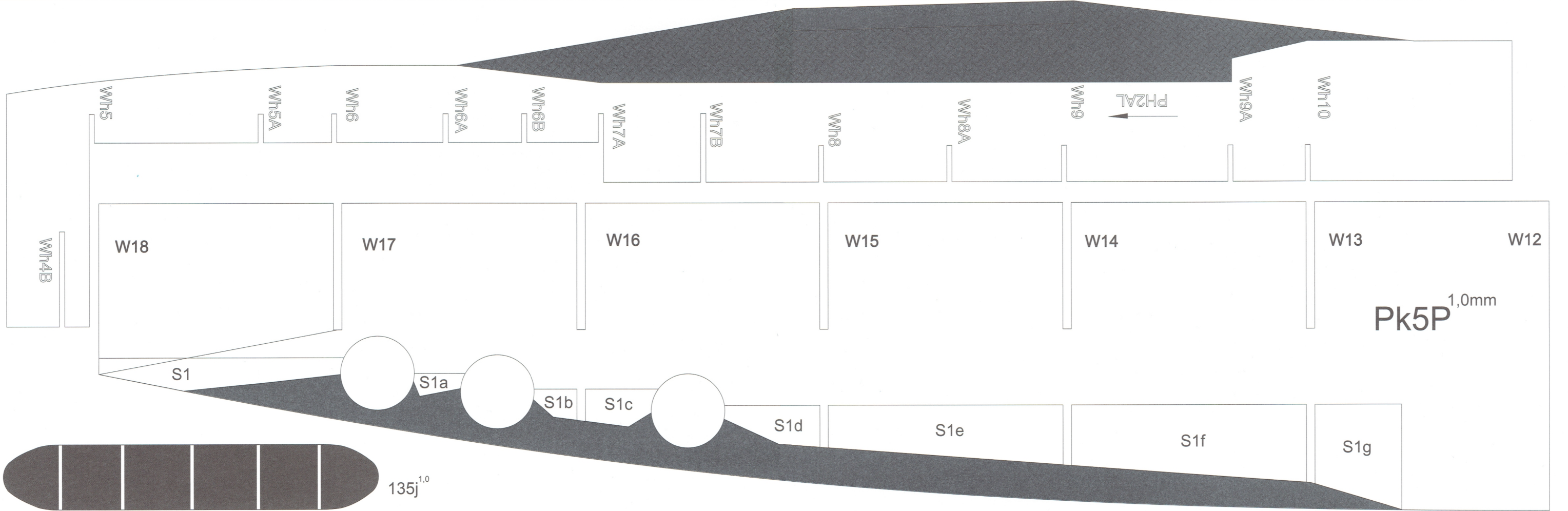
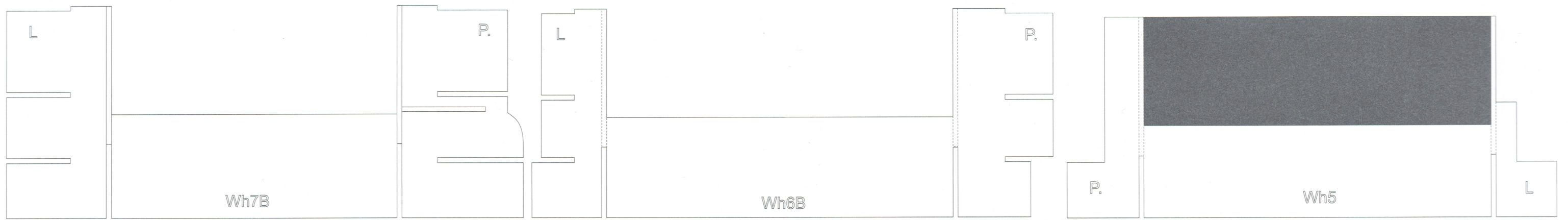

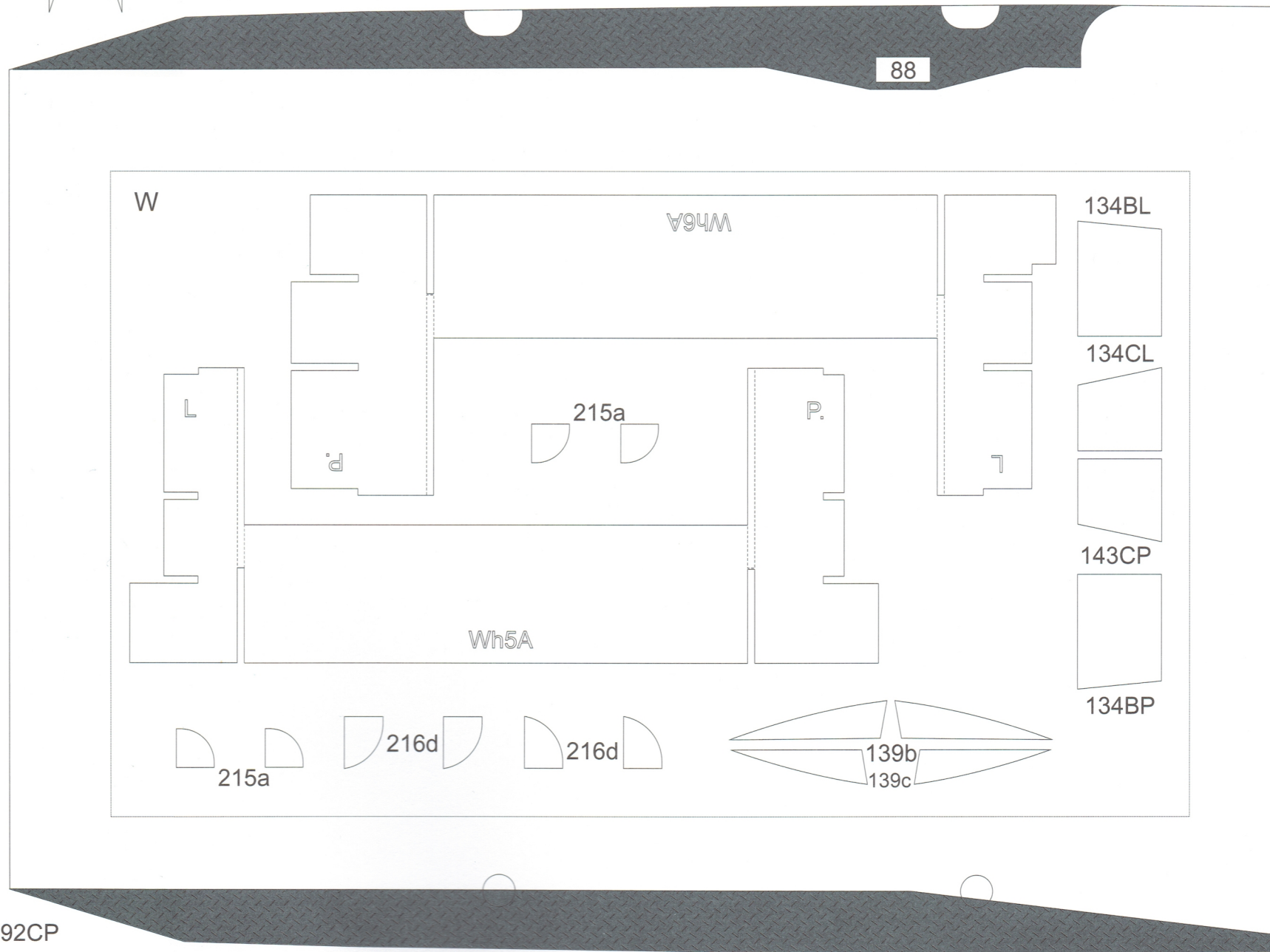
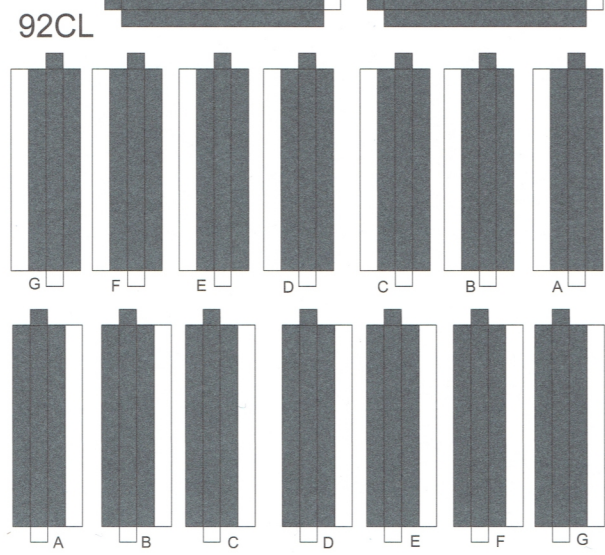
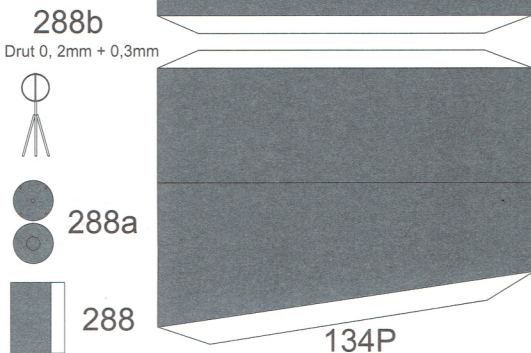
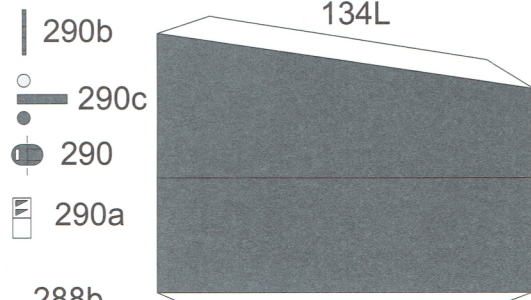
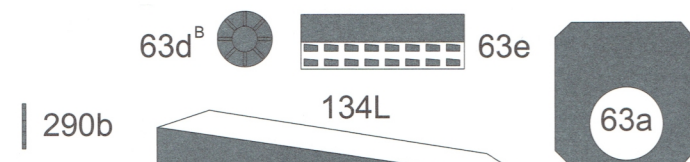
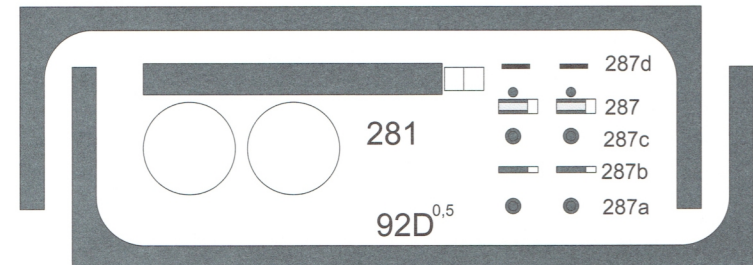
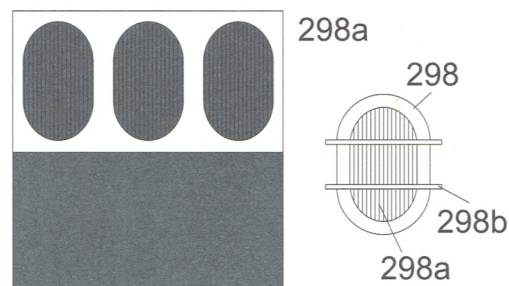
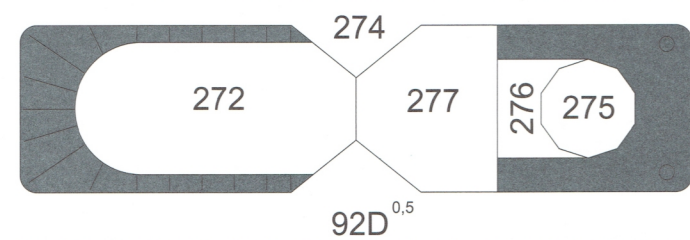
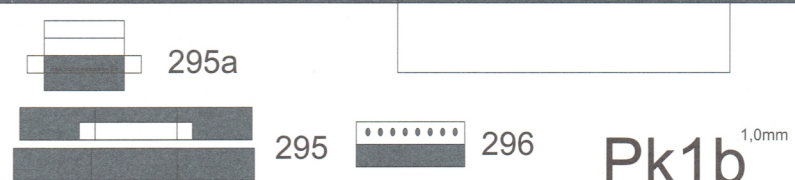
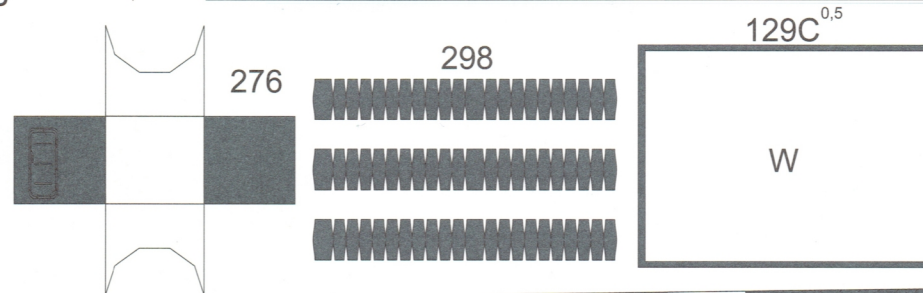
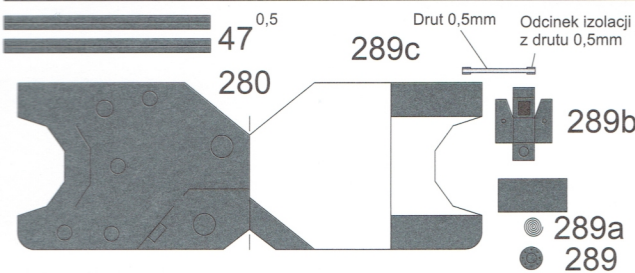

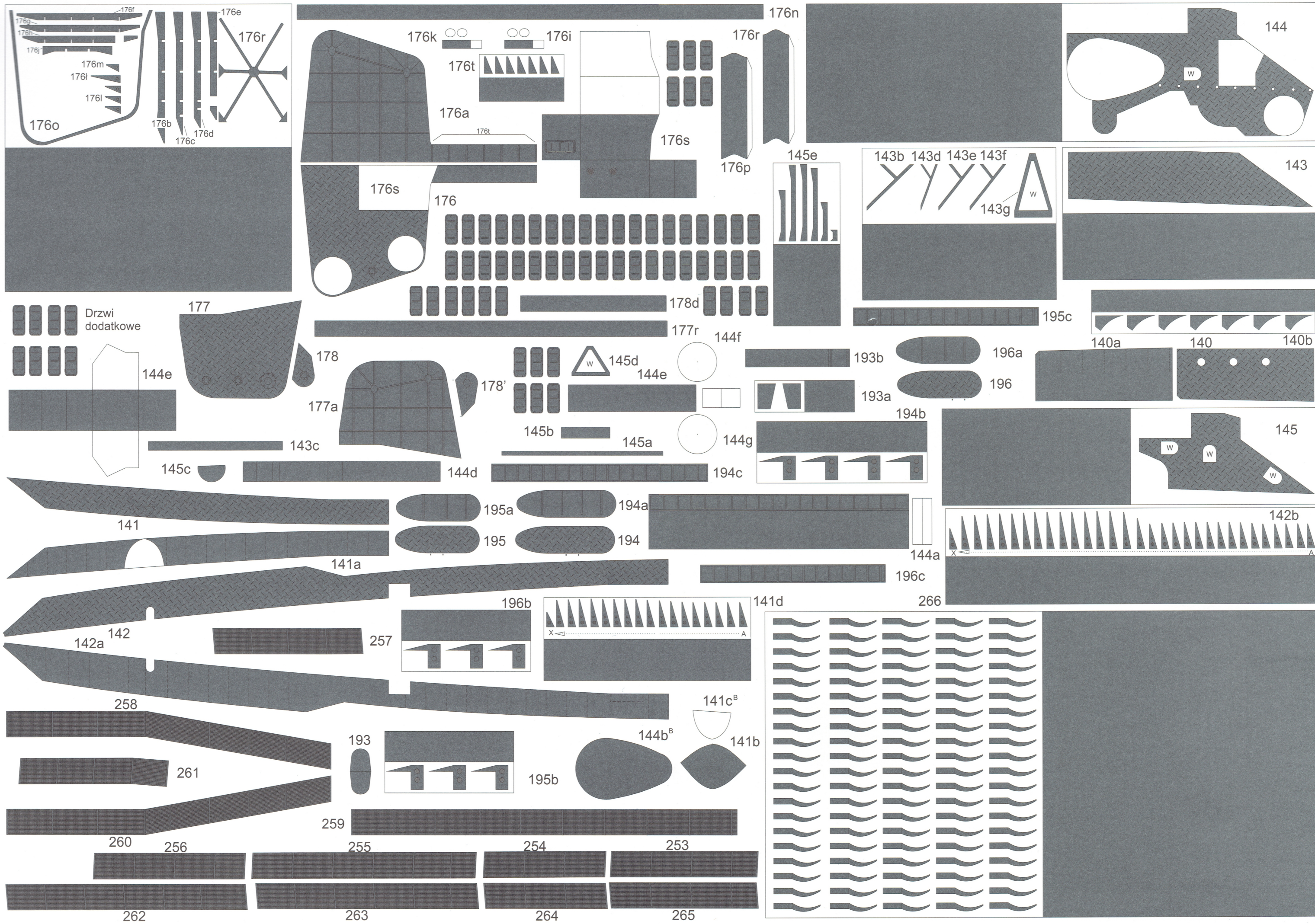

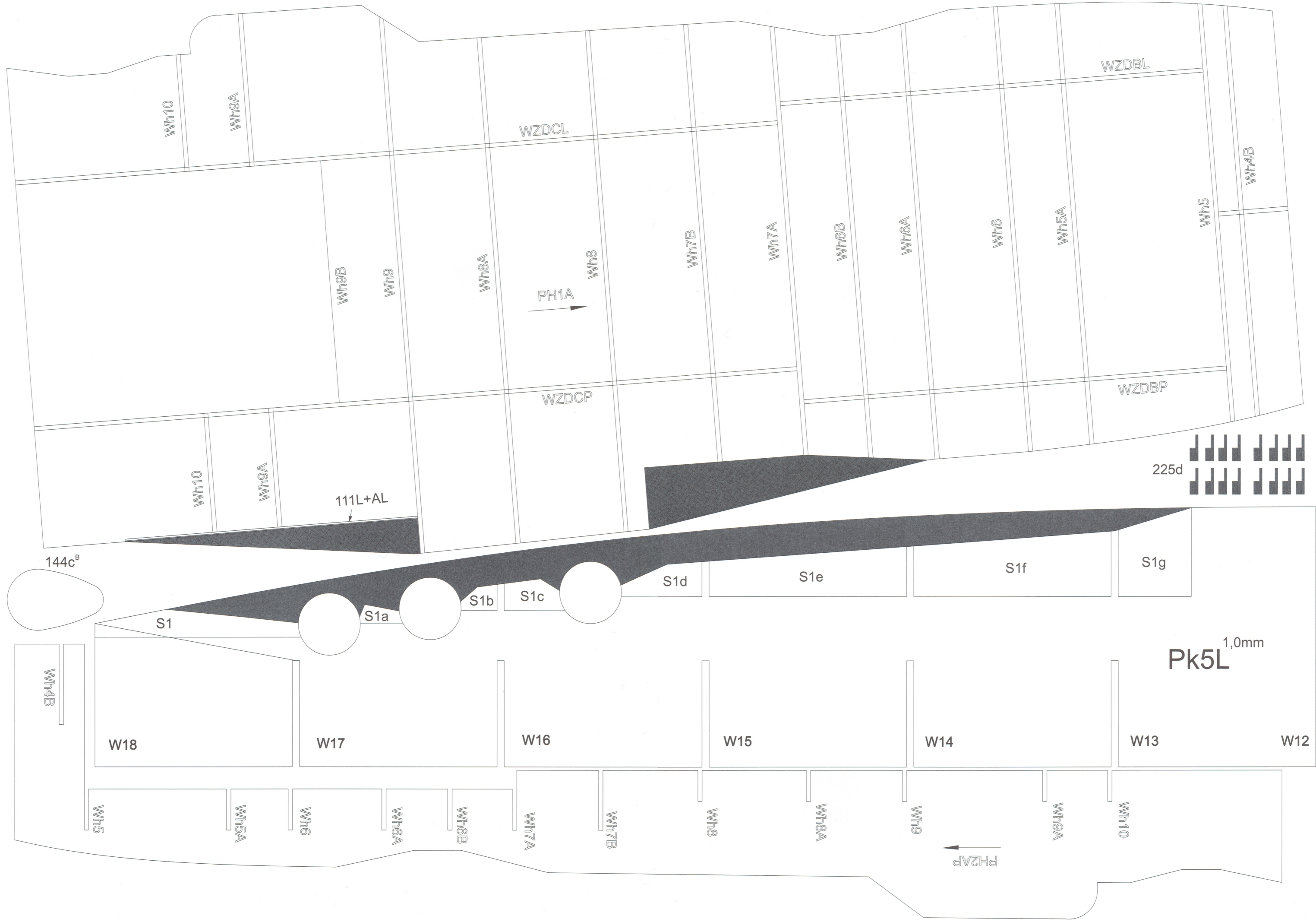

Wh10

Wh9A

WZDCL

WZDBL

Wh9B

Wh9

Wh8A

PH1A

Wh8

Wh7B

Wh7A

Wh6B

Wh6A

Wh6

Wh5A

Wh5

Wh4B

WZDCP

WZDBP

Wh10

Wh9A

111L+AL

225d

144c^B

S1

S1a

S1b

S1c

S1d

S1e

S1f

S1g

Wh4B

W18

W17

W16

W15

W14

W13

W12

PK5L 1,0mm

Wh5

Wh5A

Wh6

Wh6A

Wh6B

Wh7A

Wh7B

Wh8

Wh8A

Wh9

Wh9A

Wh10

PH2AP

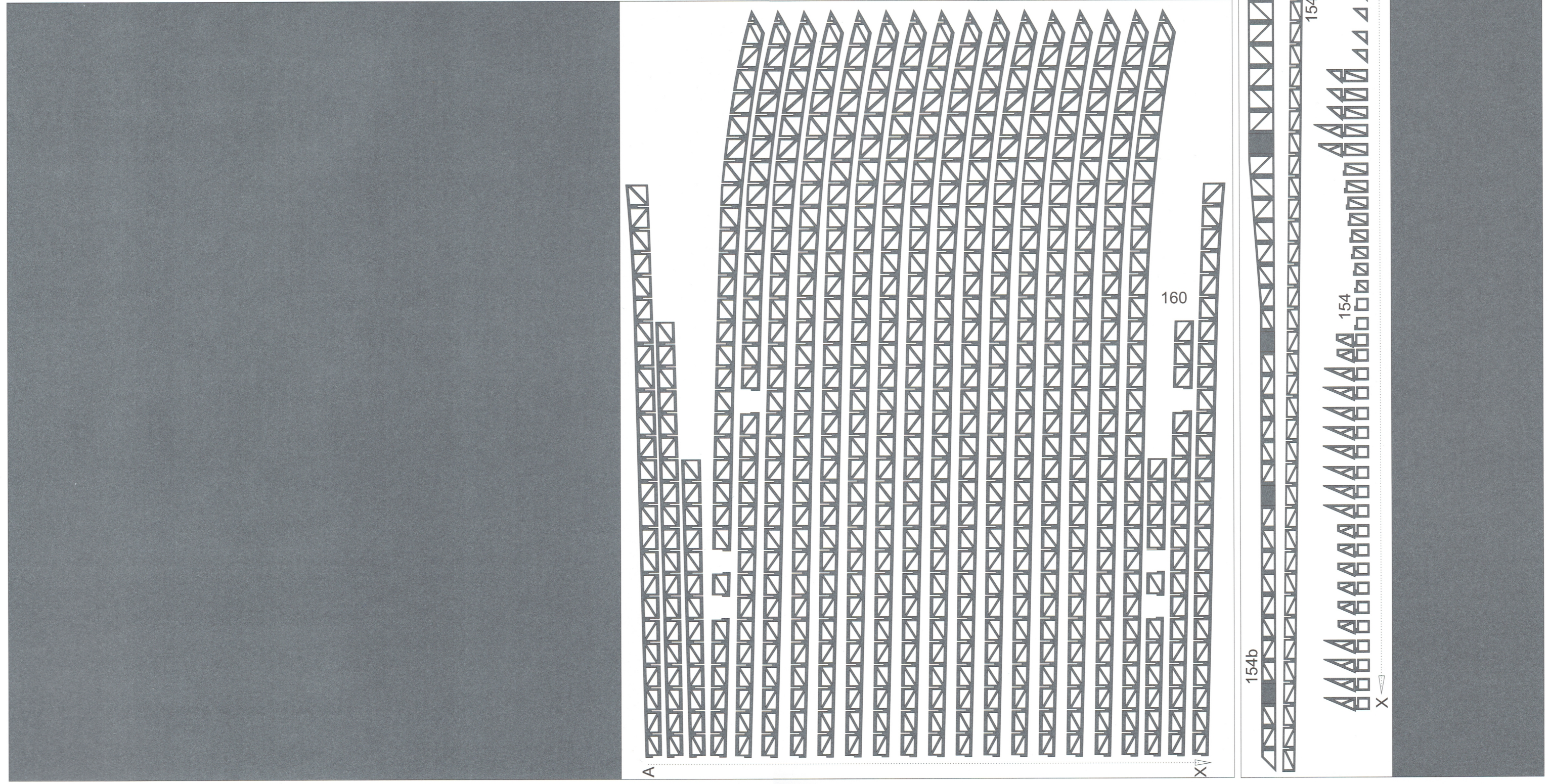
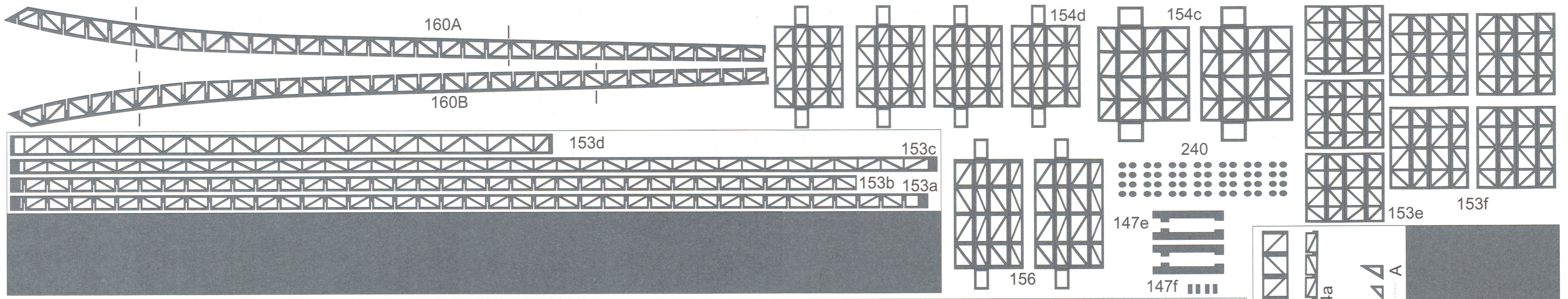

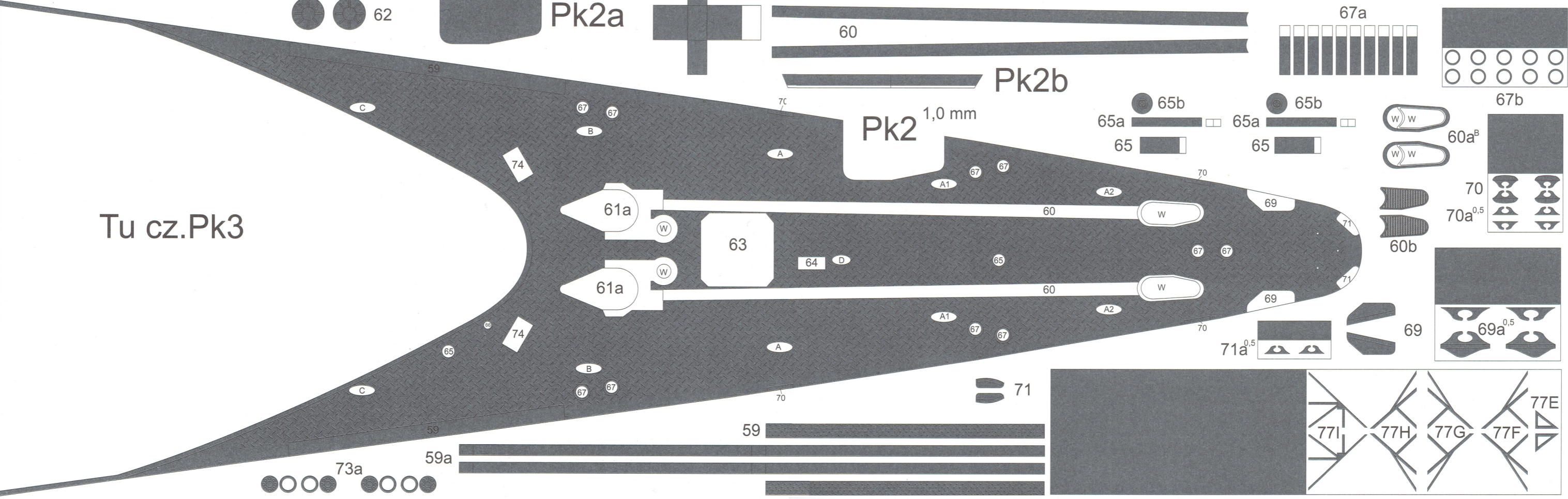
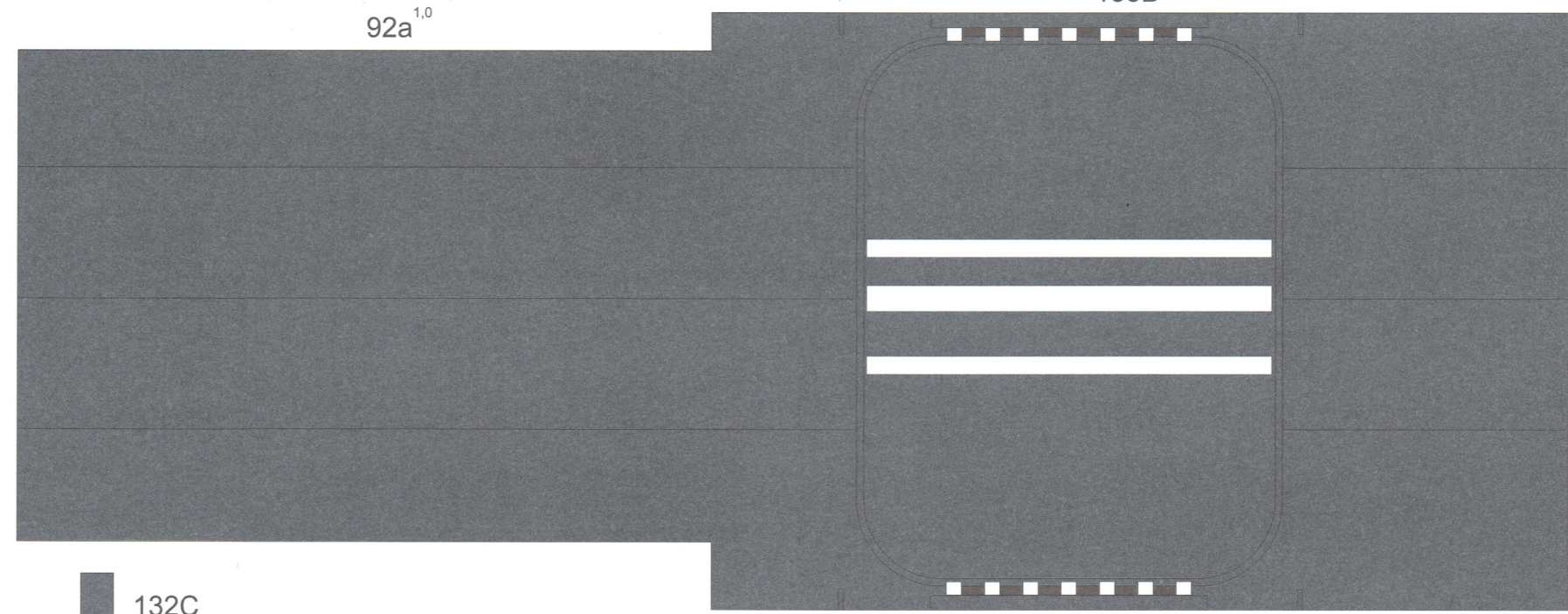
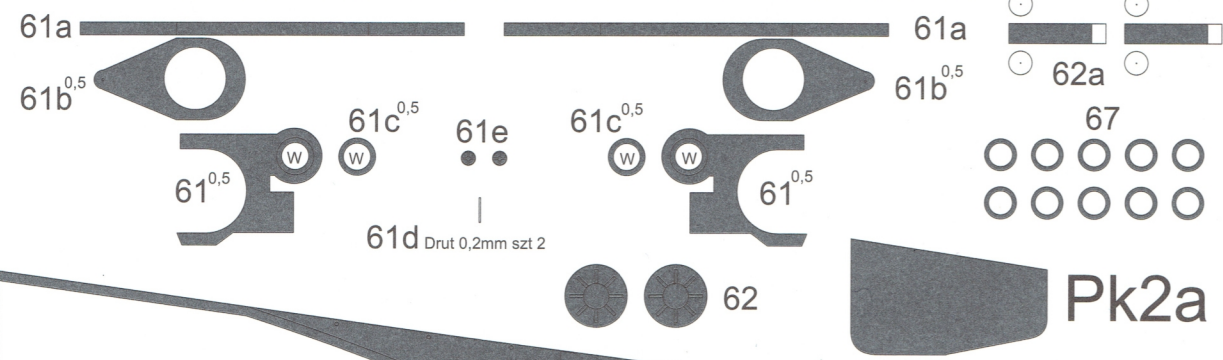
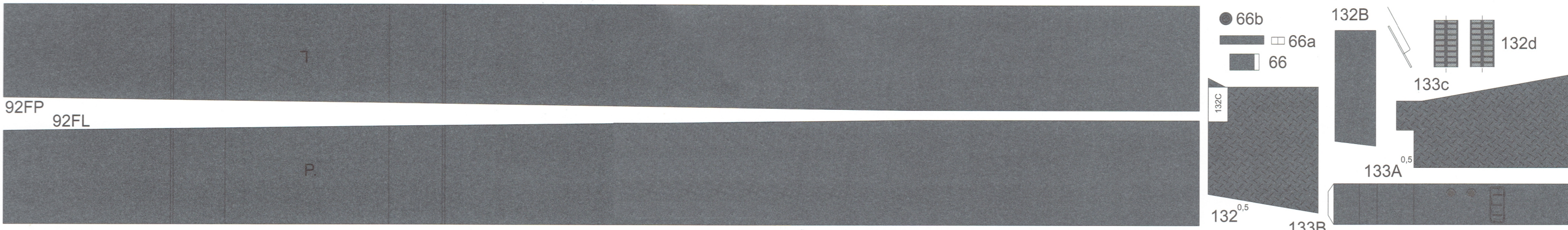

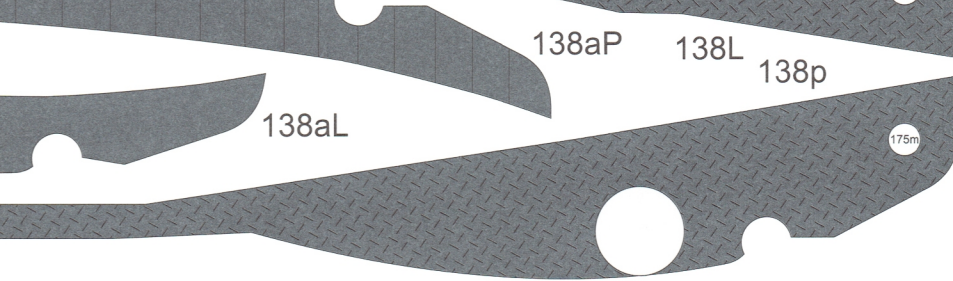
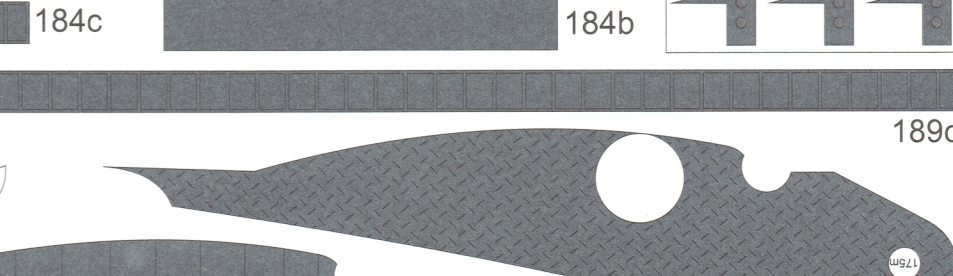
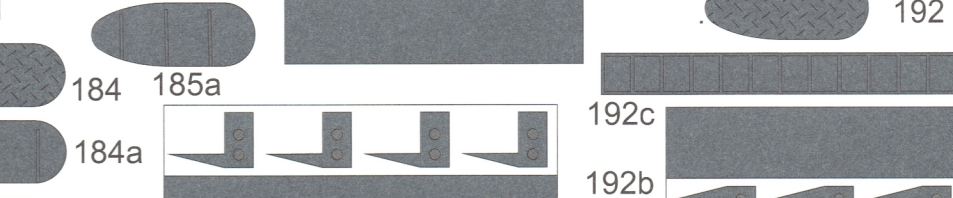
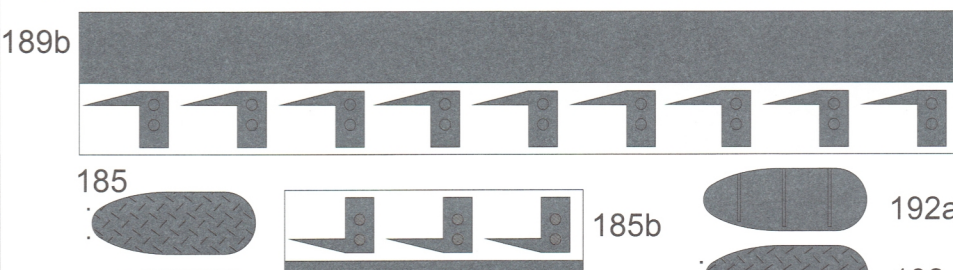
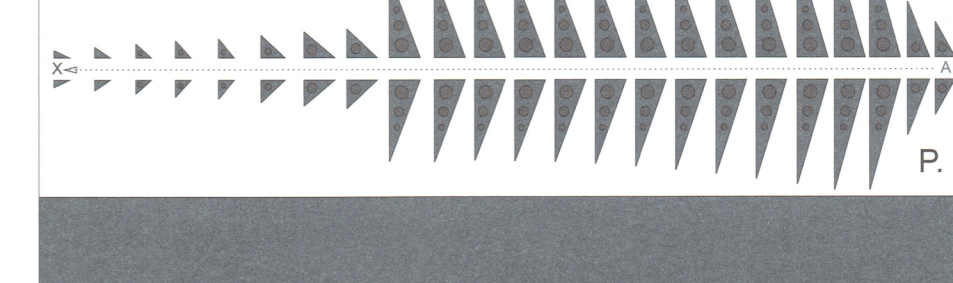
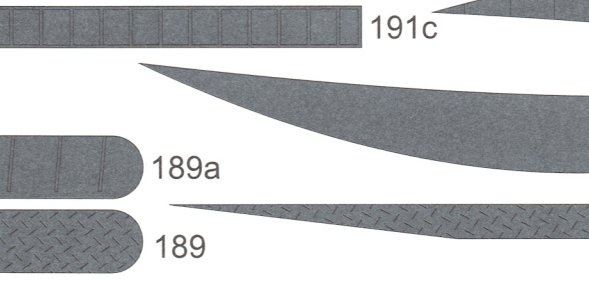
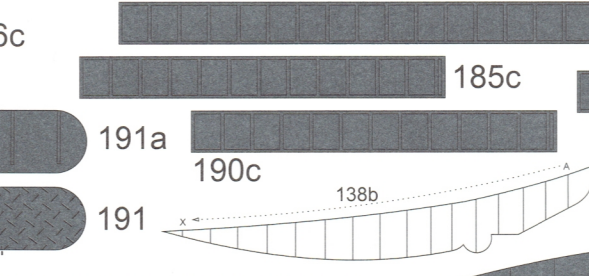
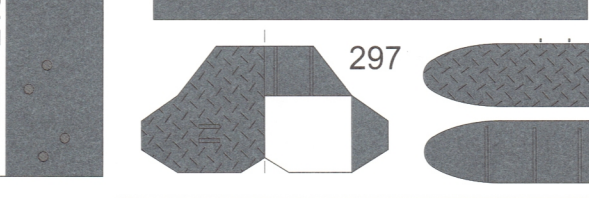
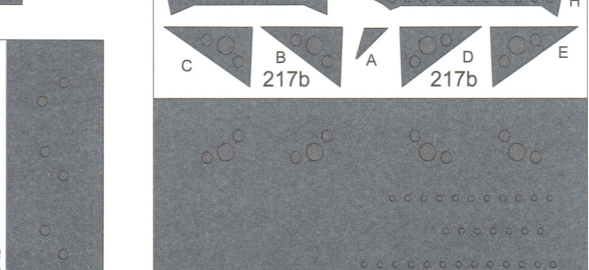
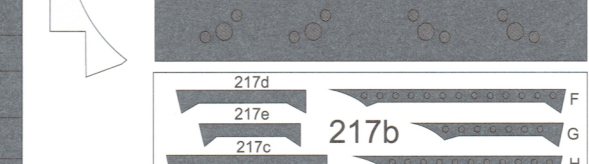
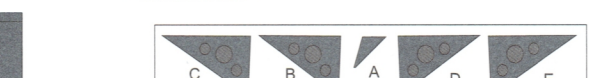
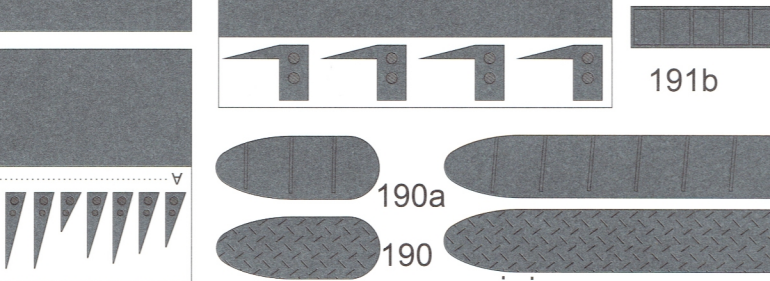
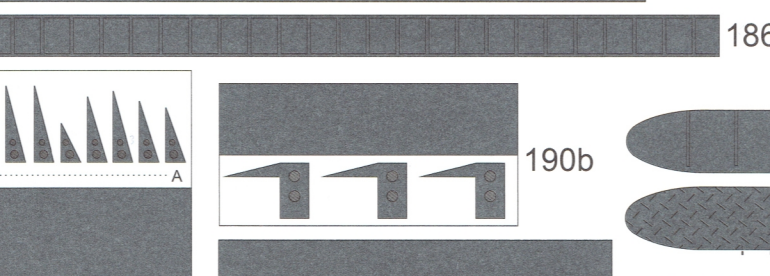
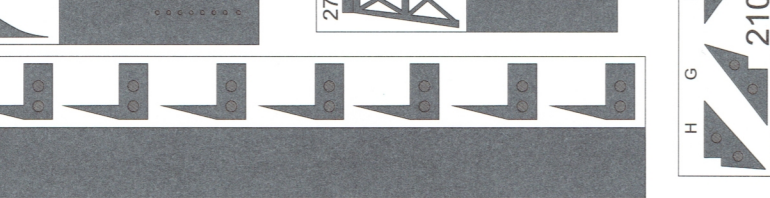
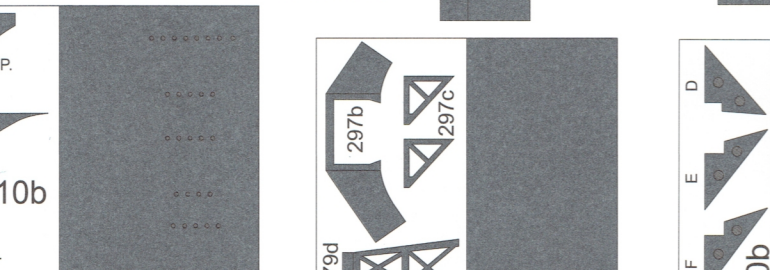
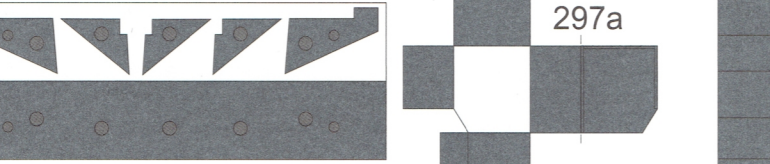
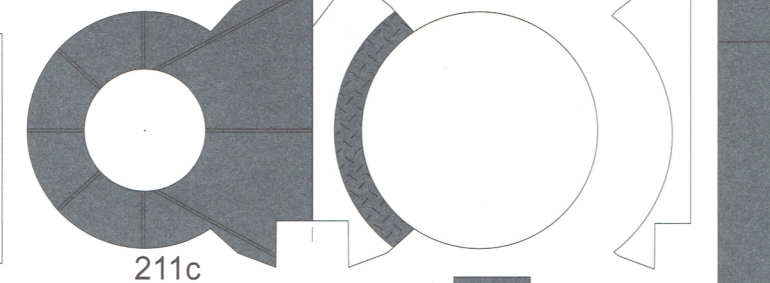
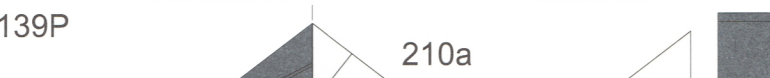
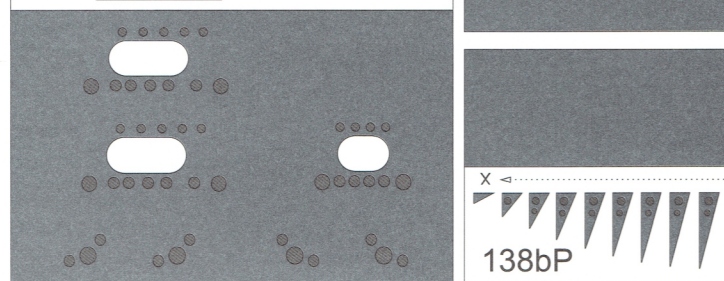
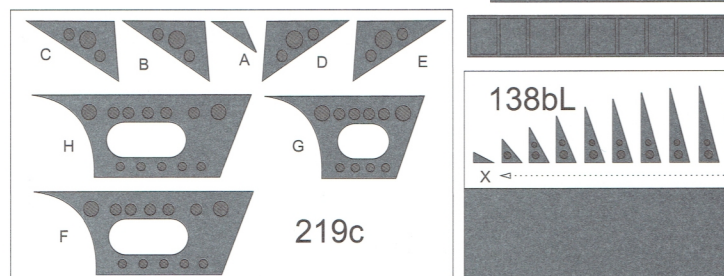
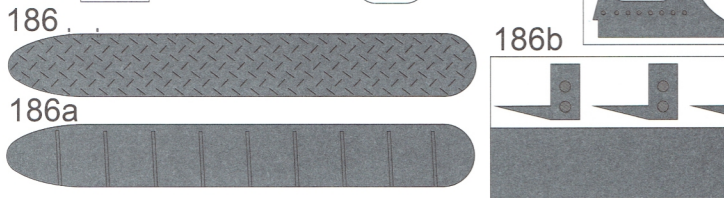
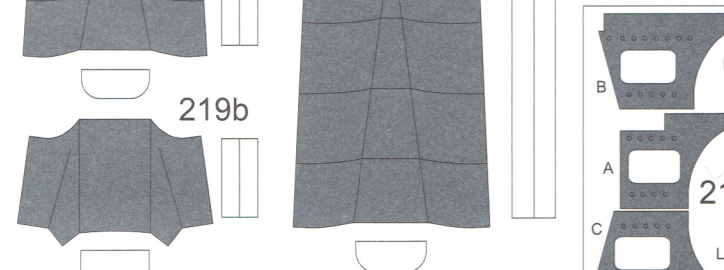
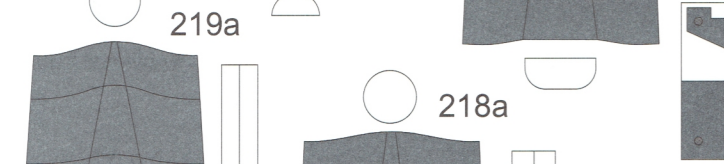
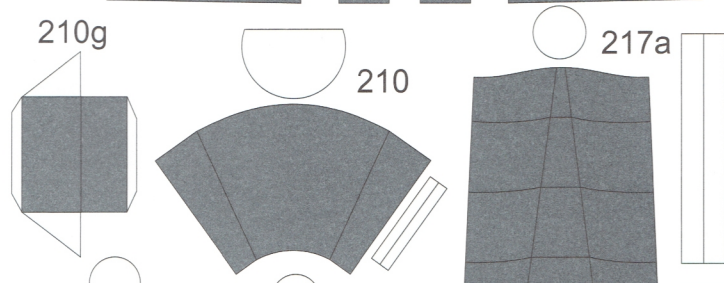
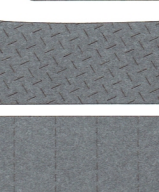
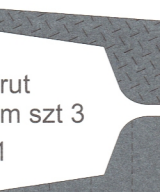
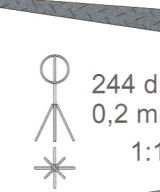
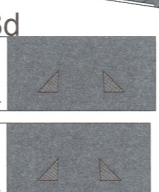
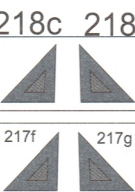
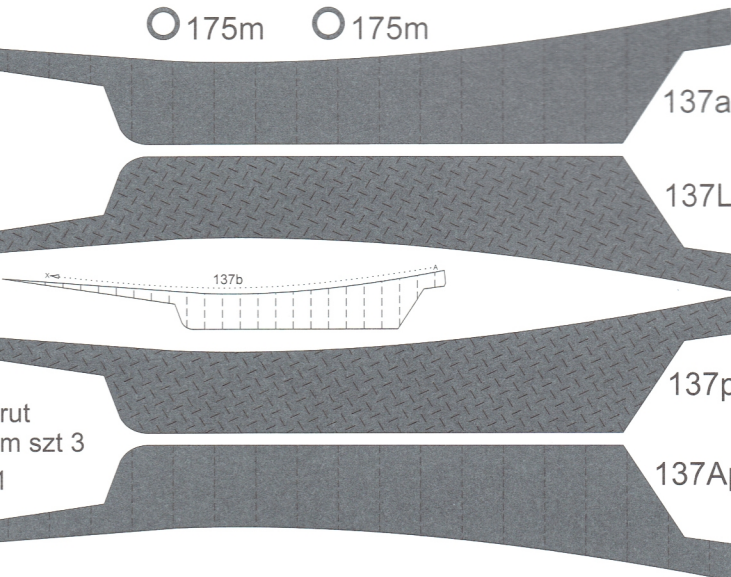
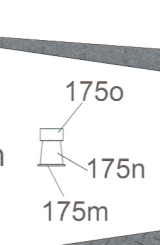
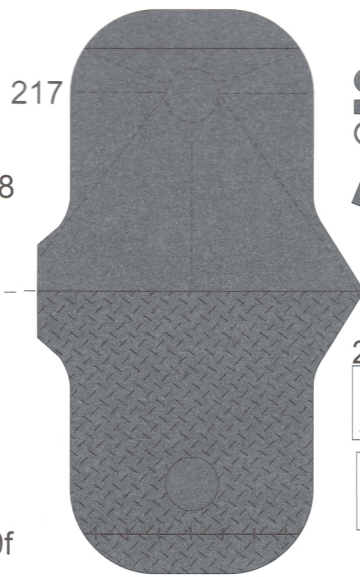
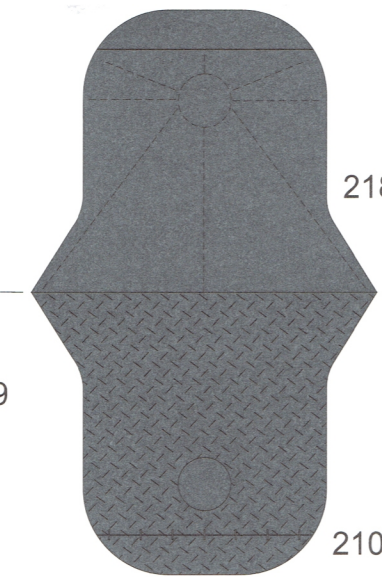
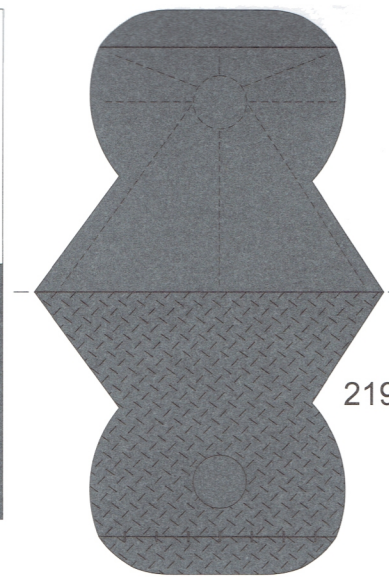
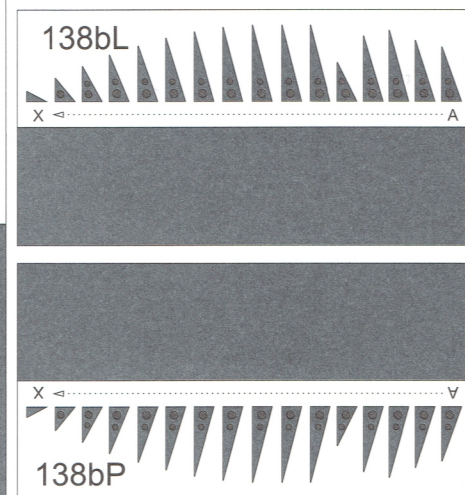
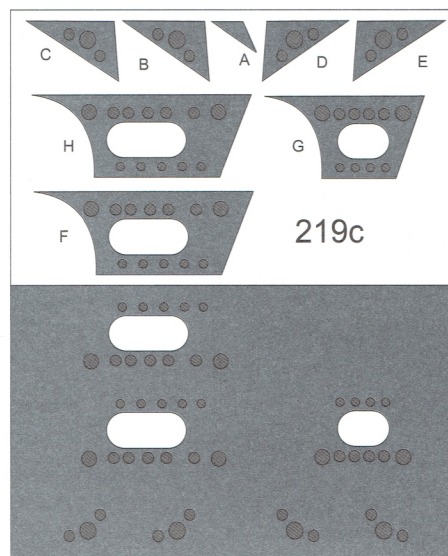
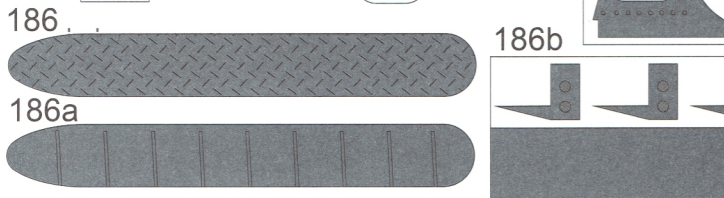
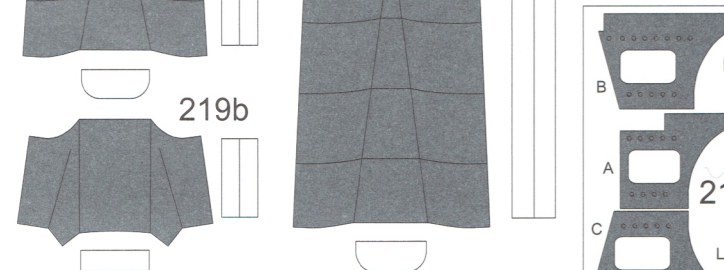
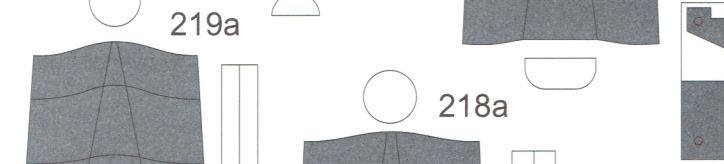
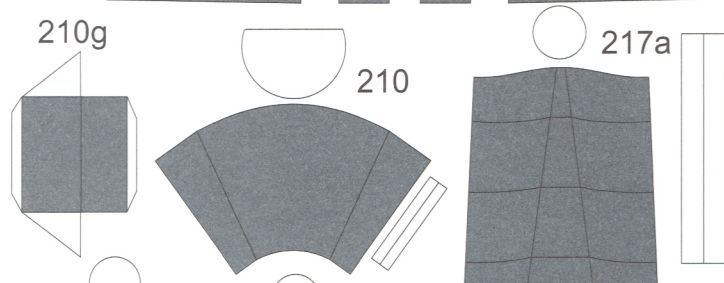
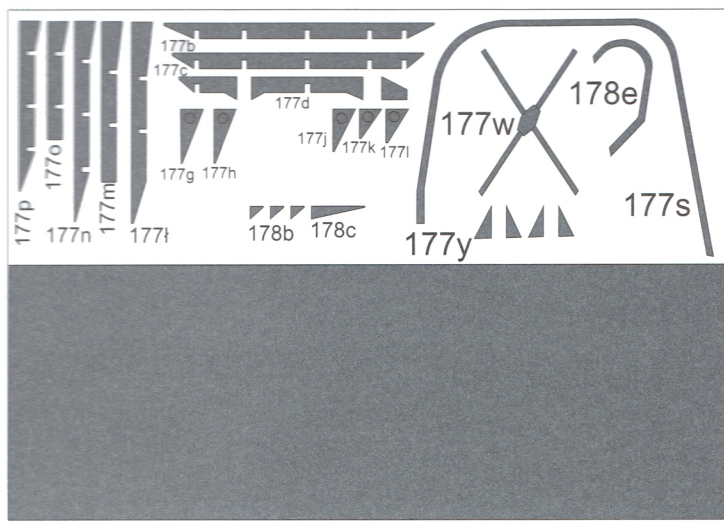

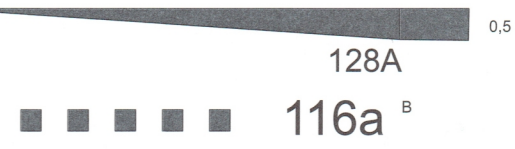
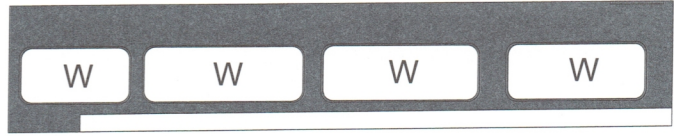
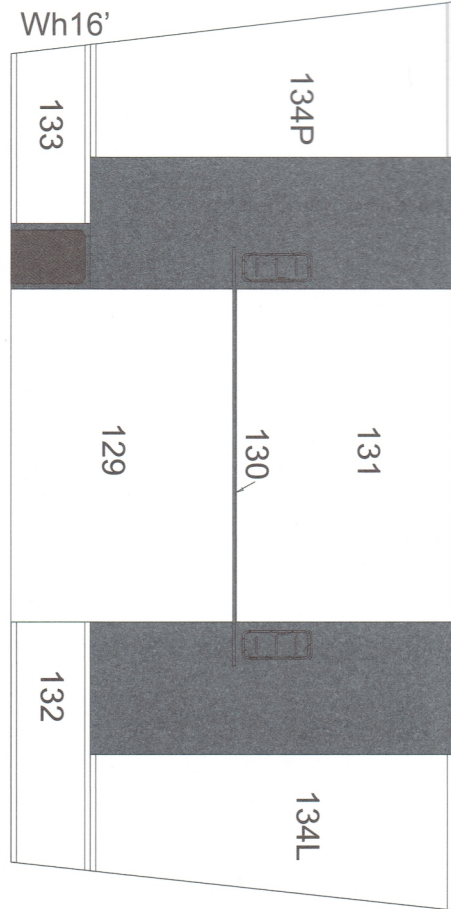
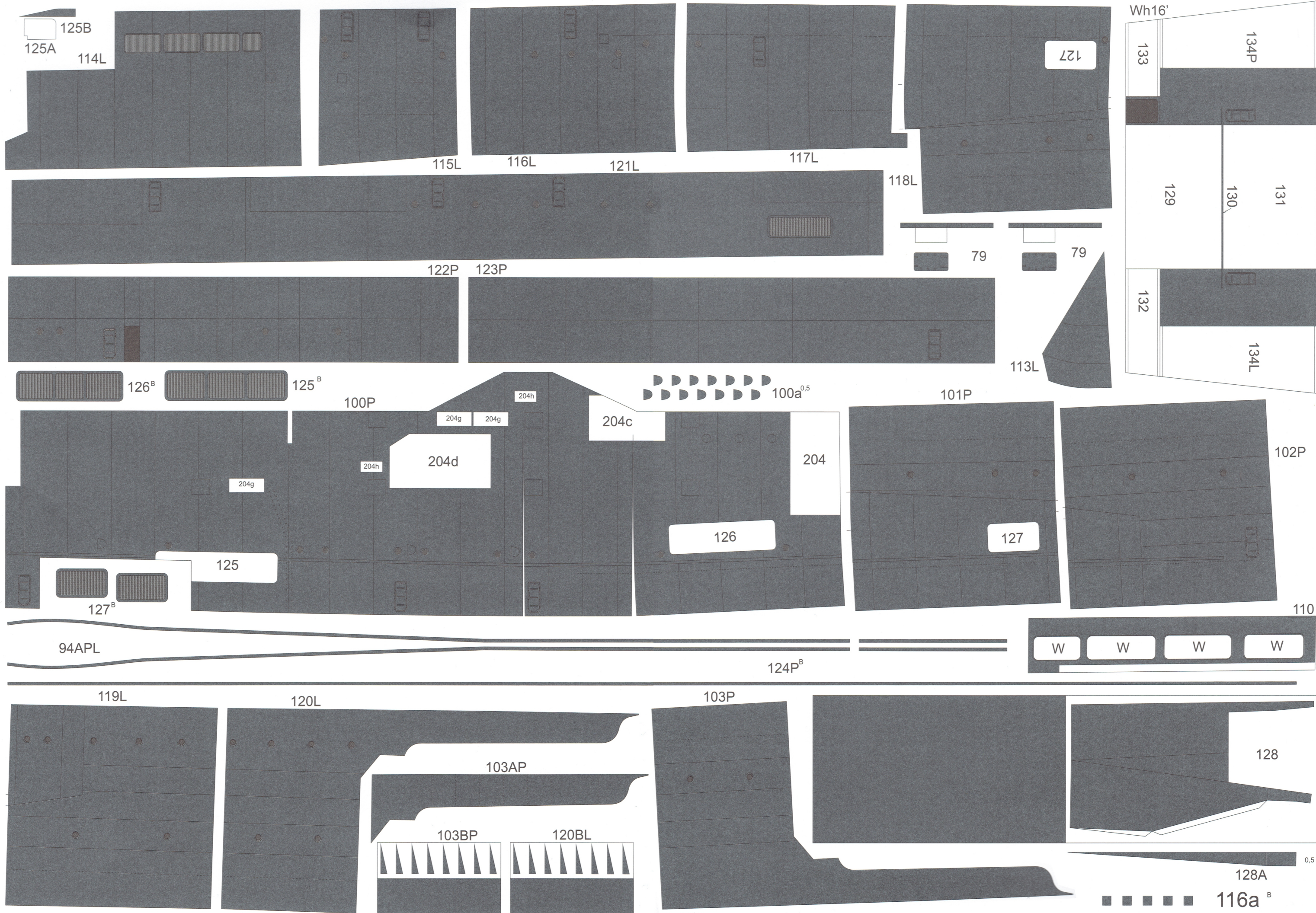

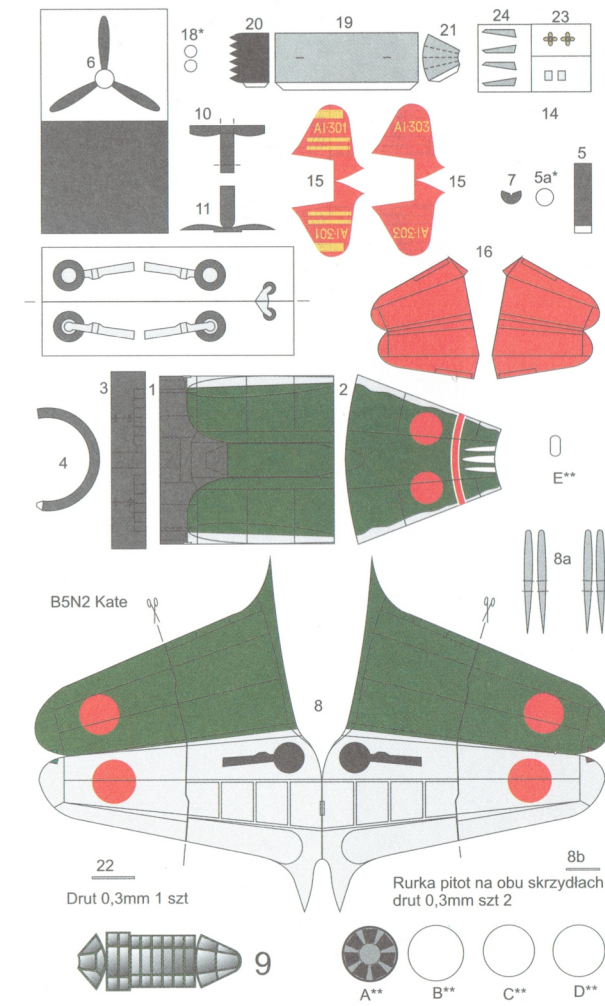
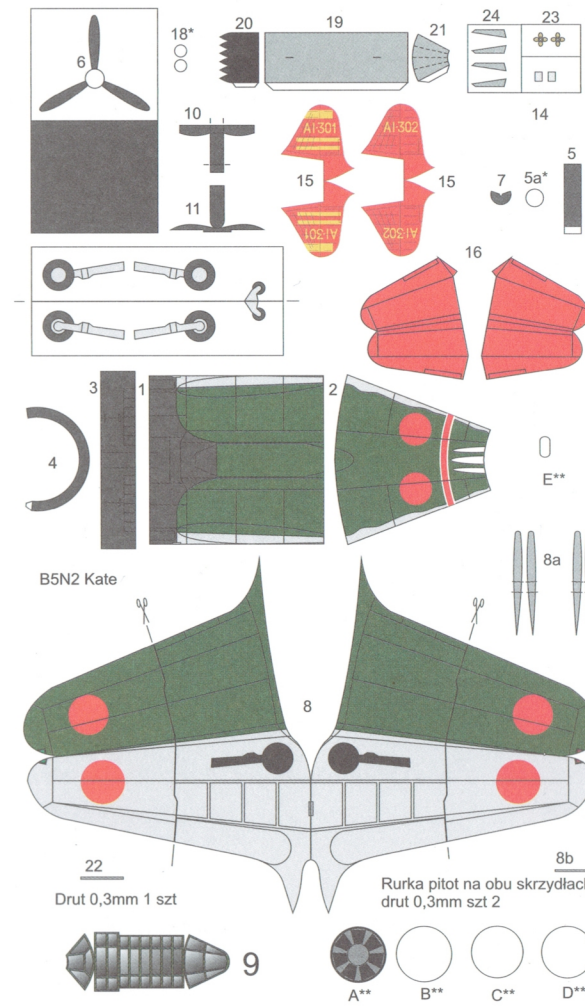
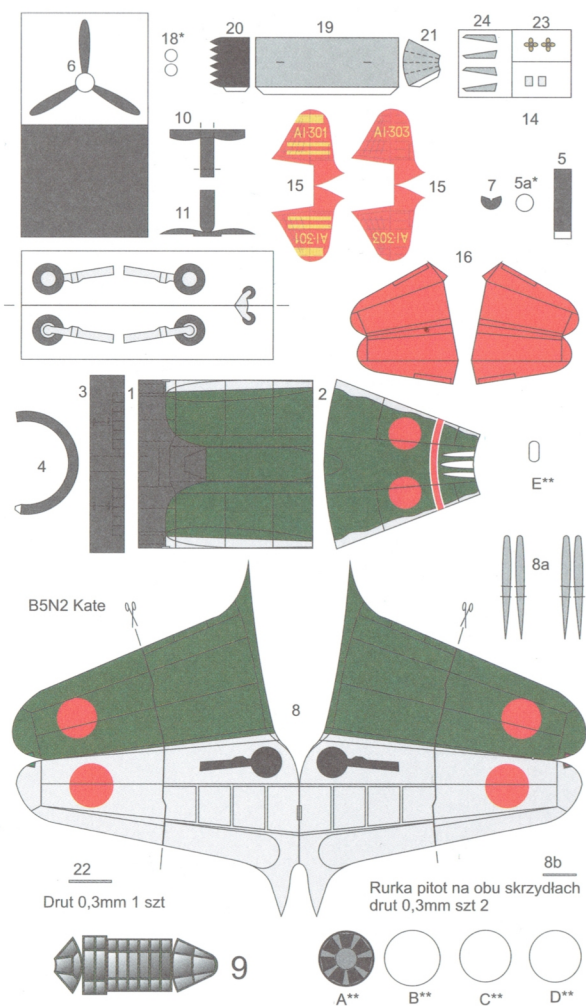
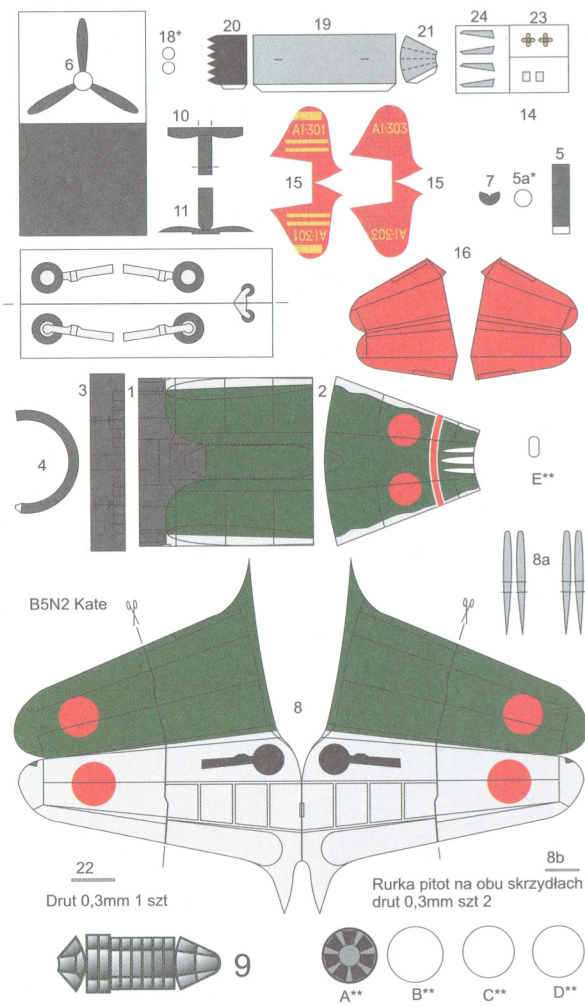
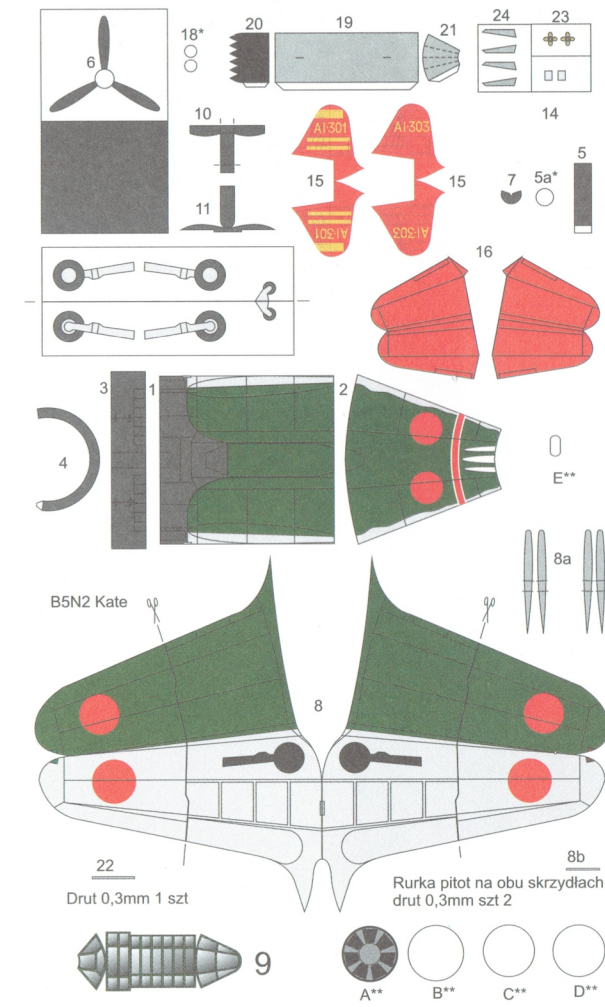
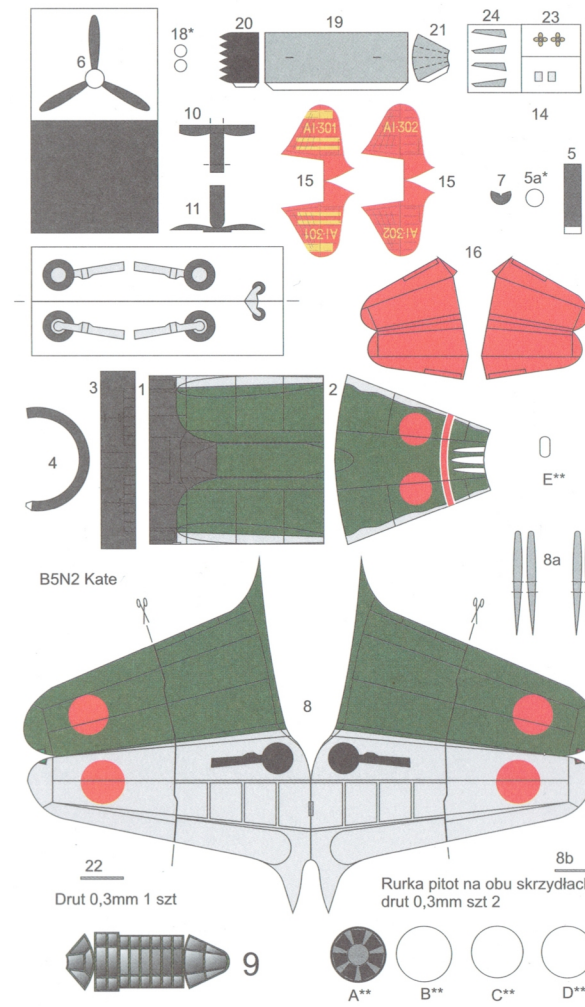
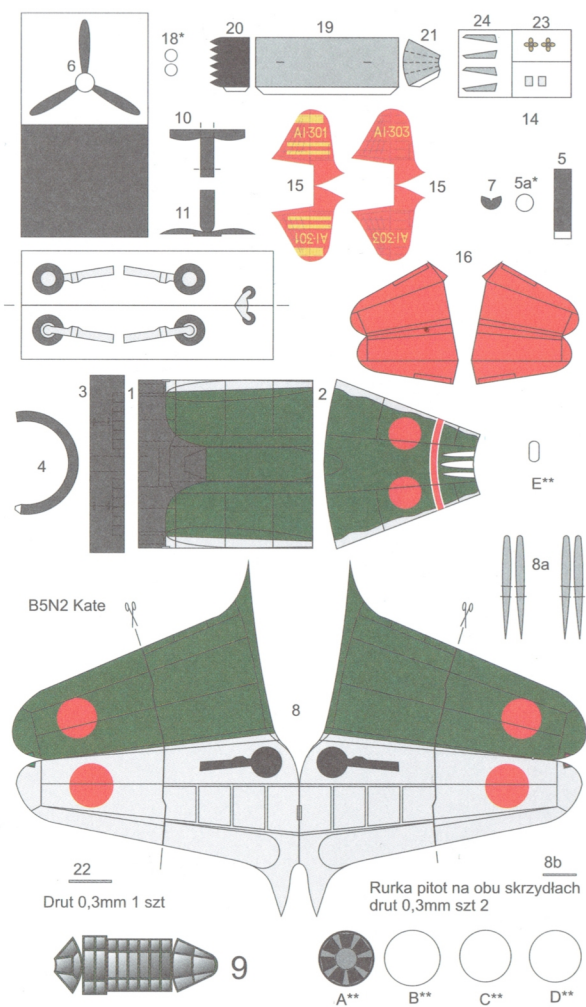
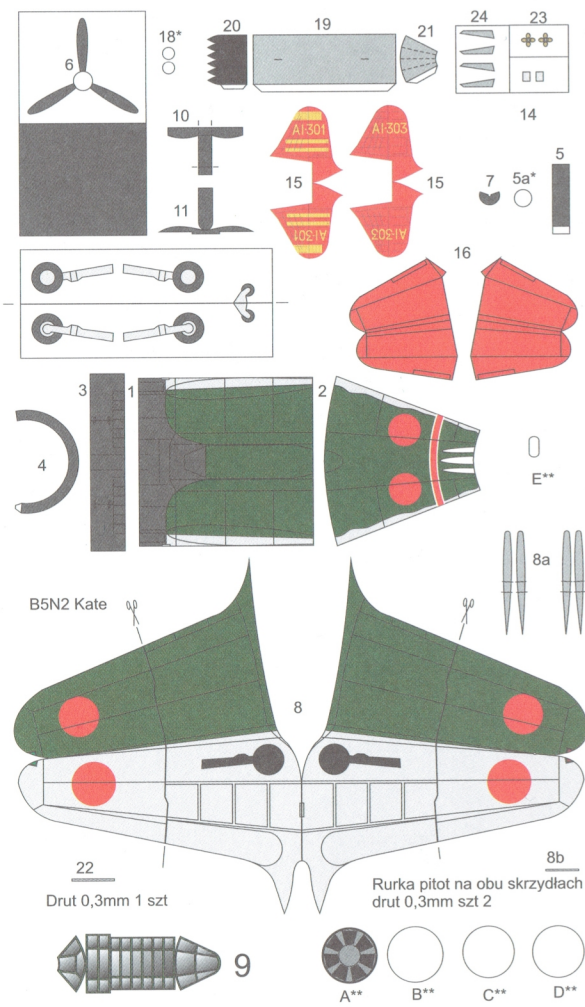

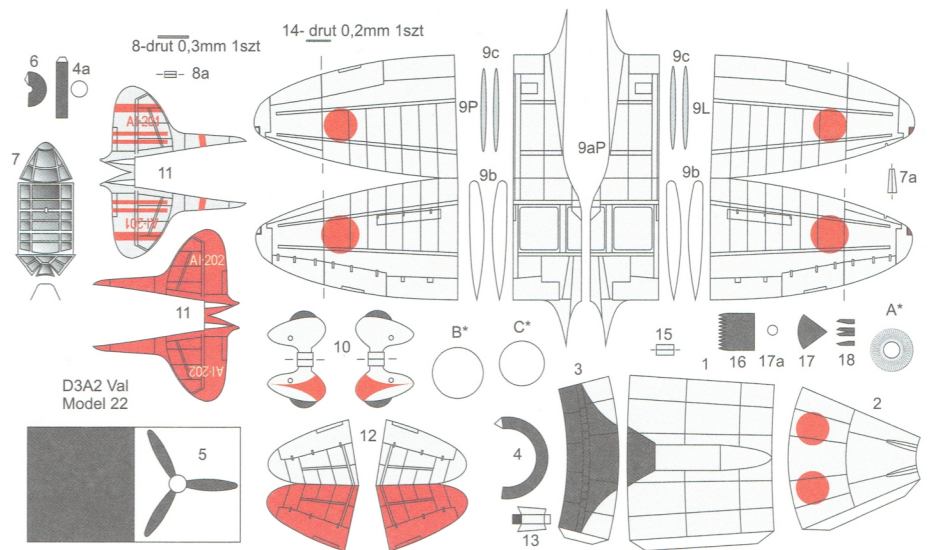
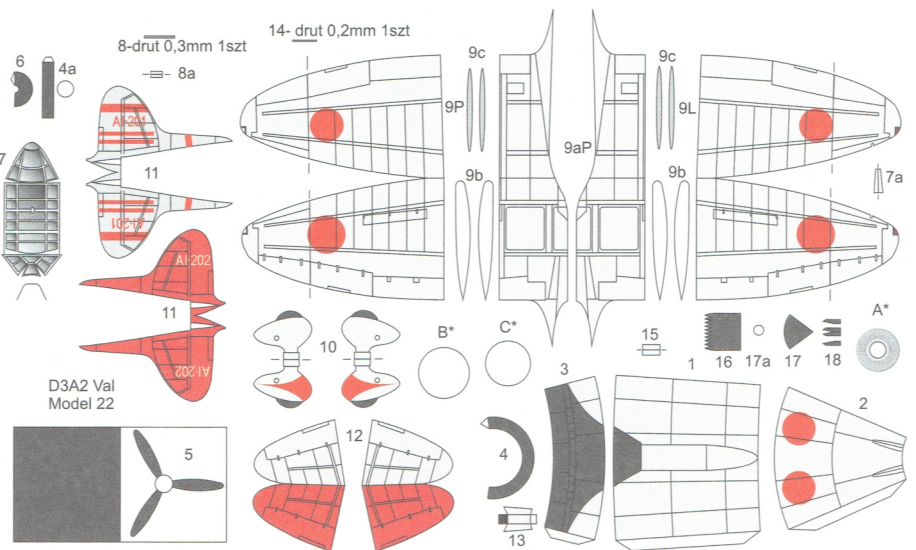
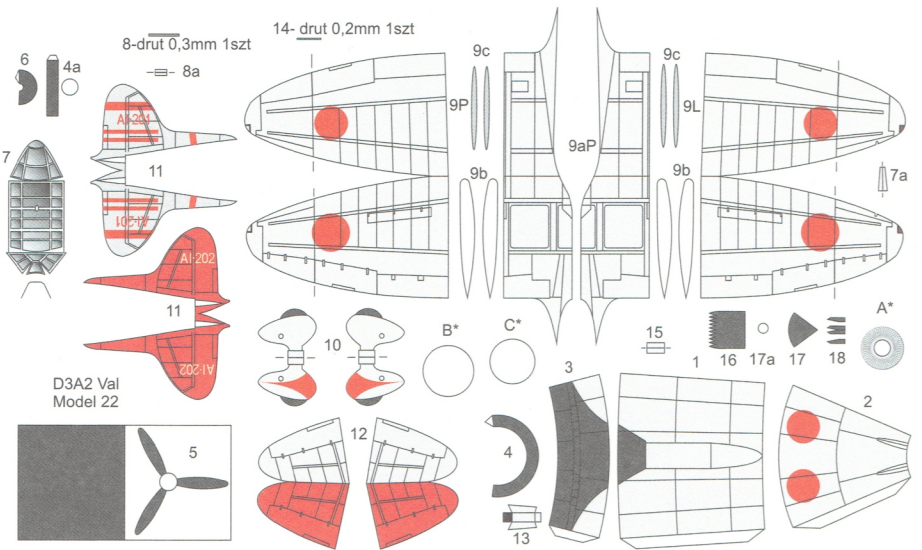
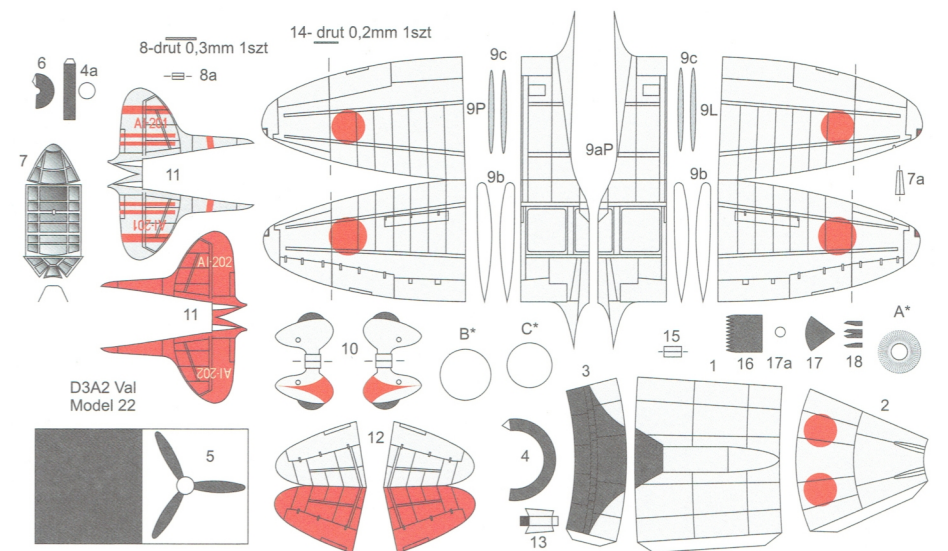
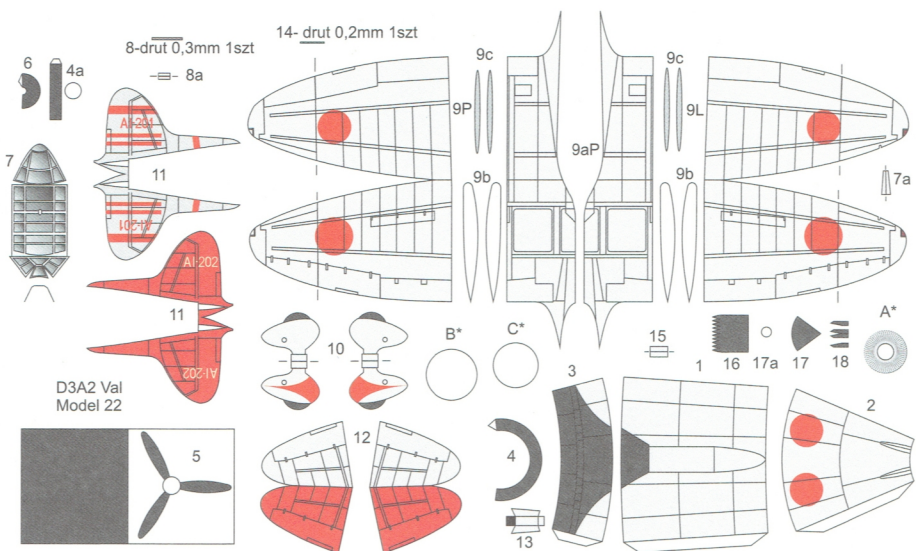
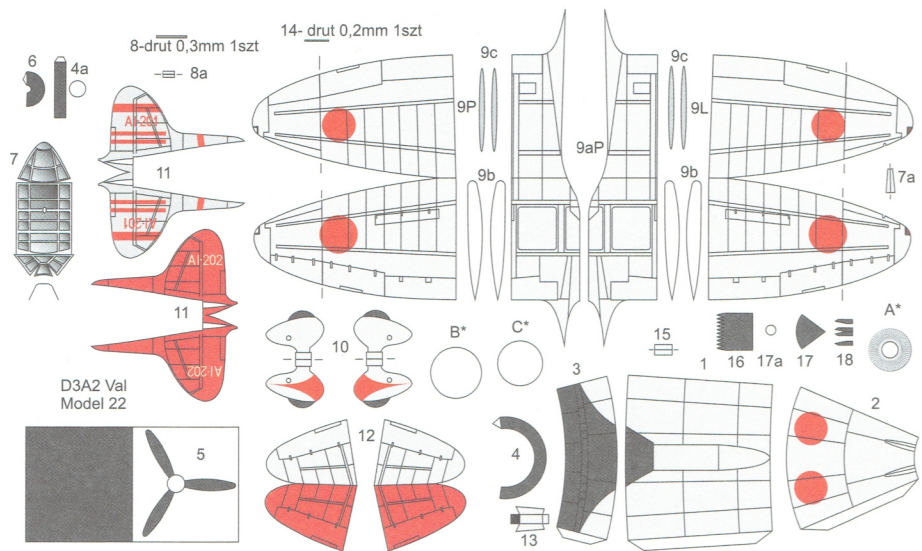
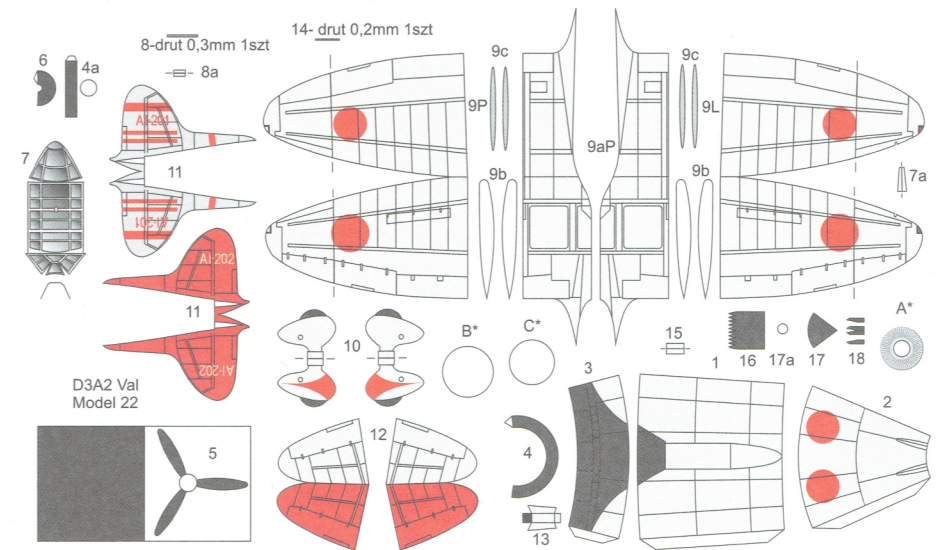
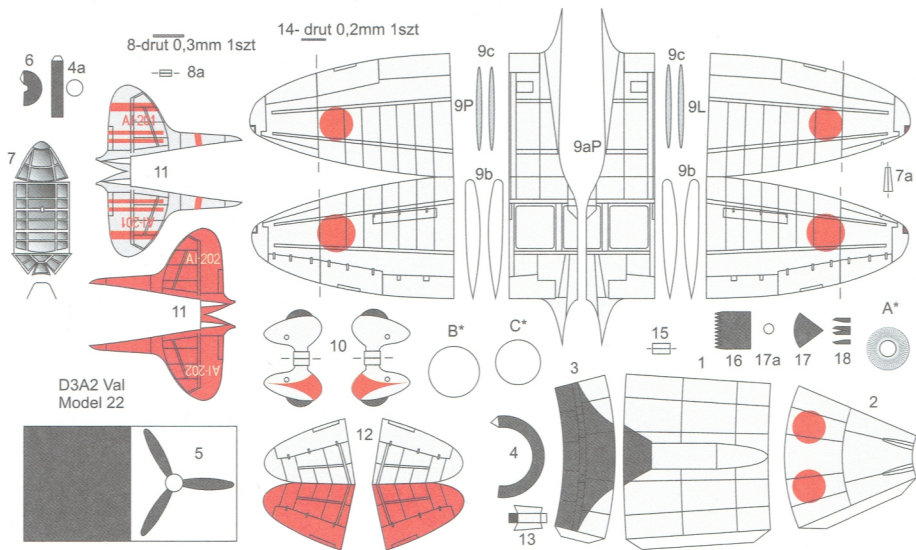
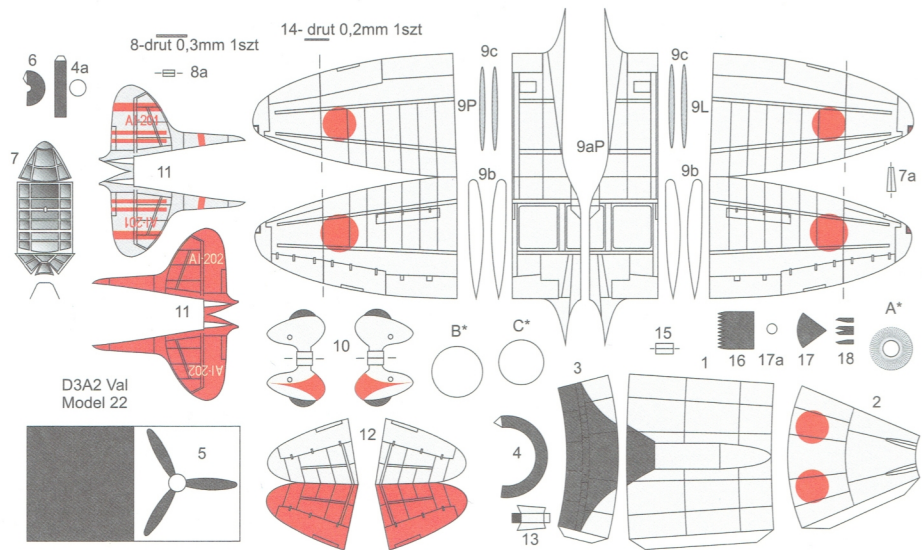

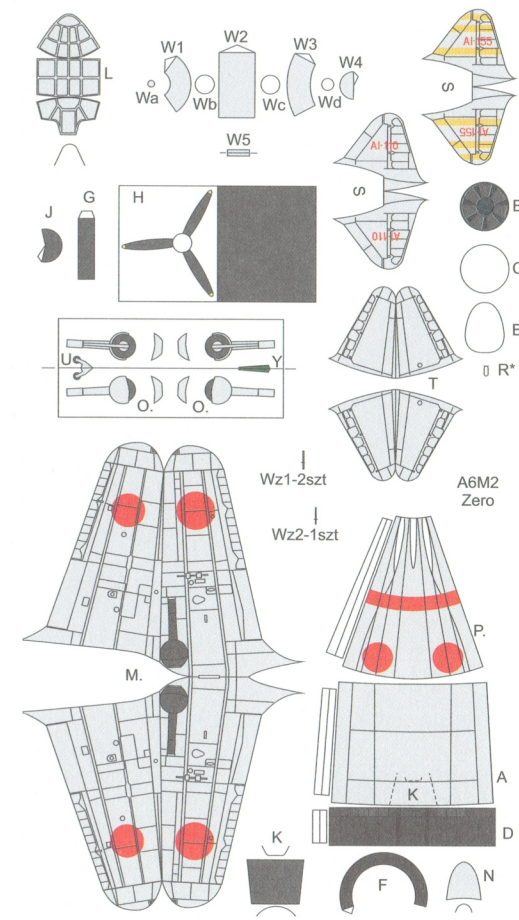
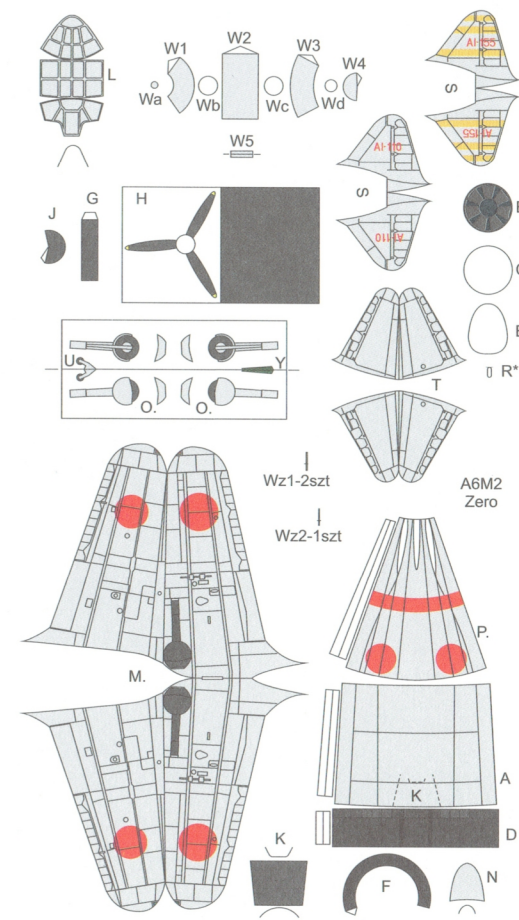
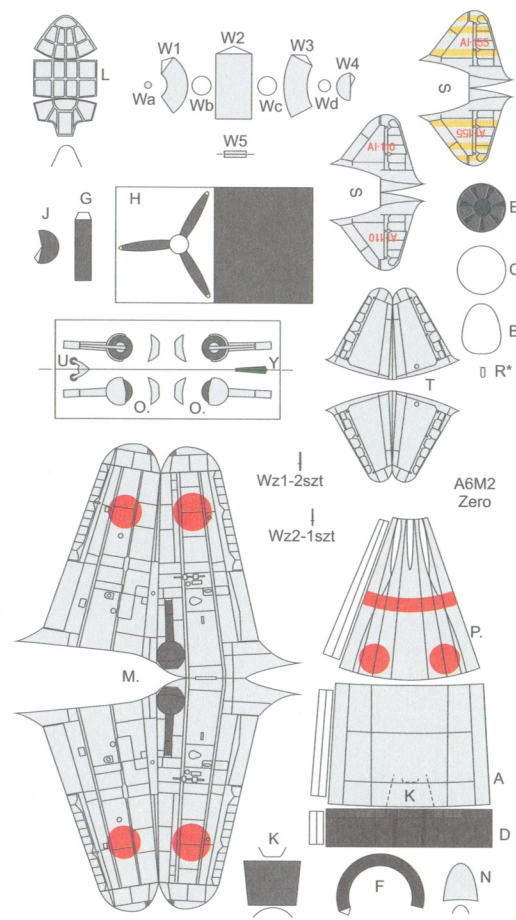
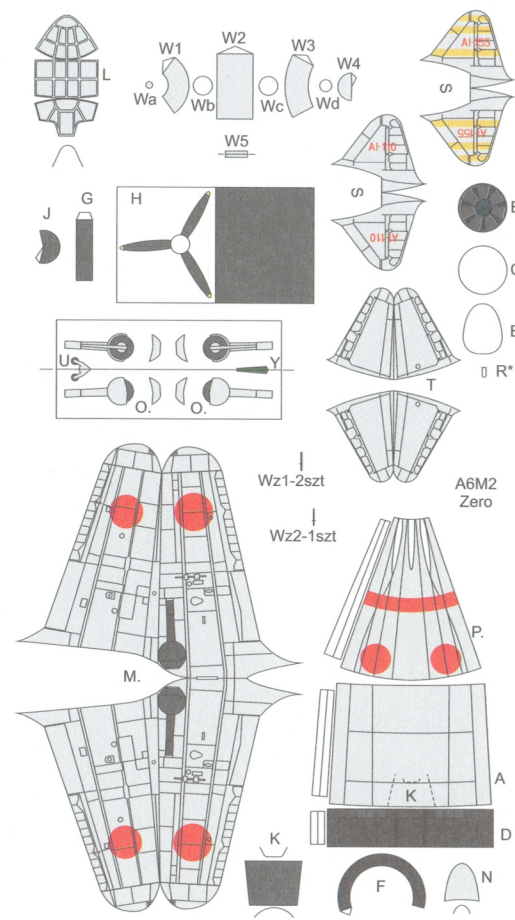
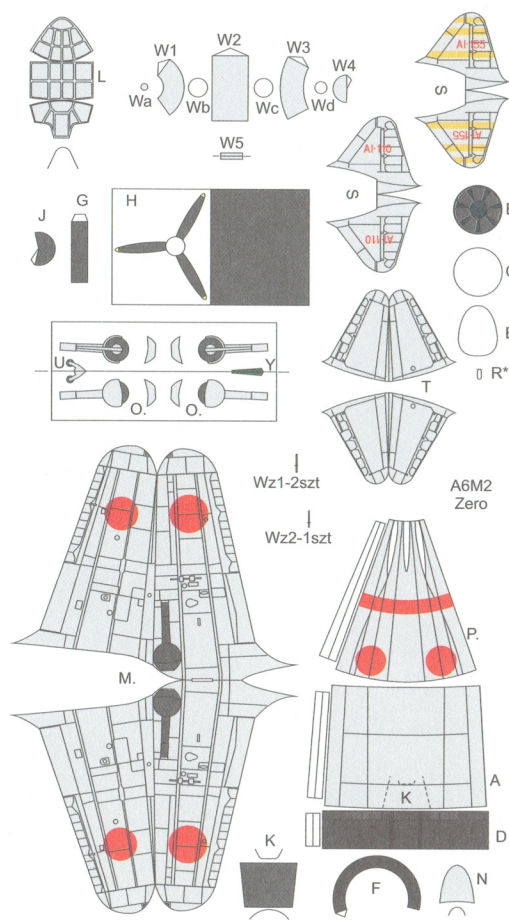
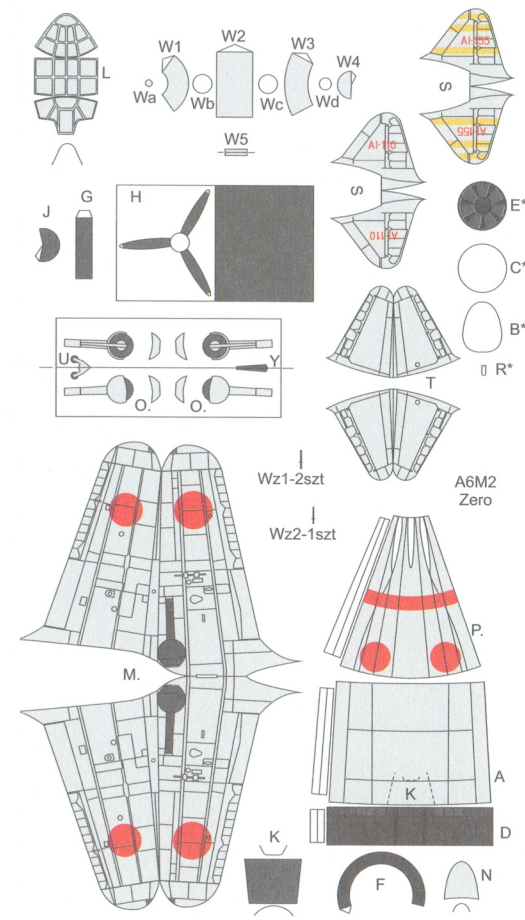
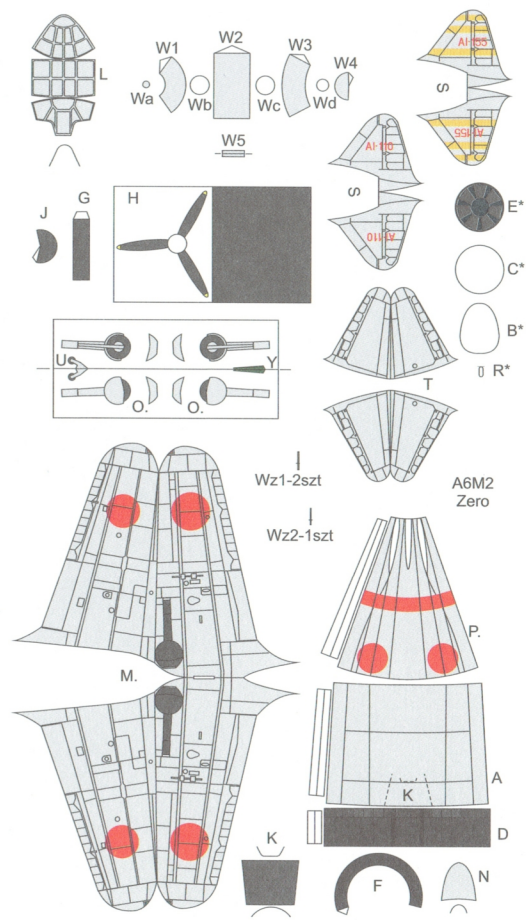
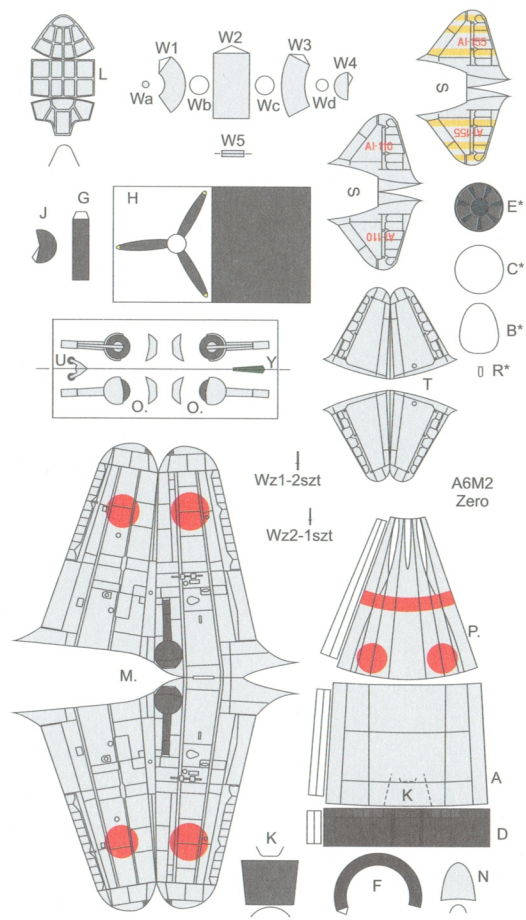
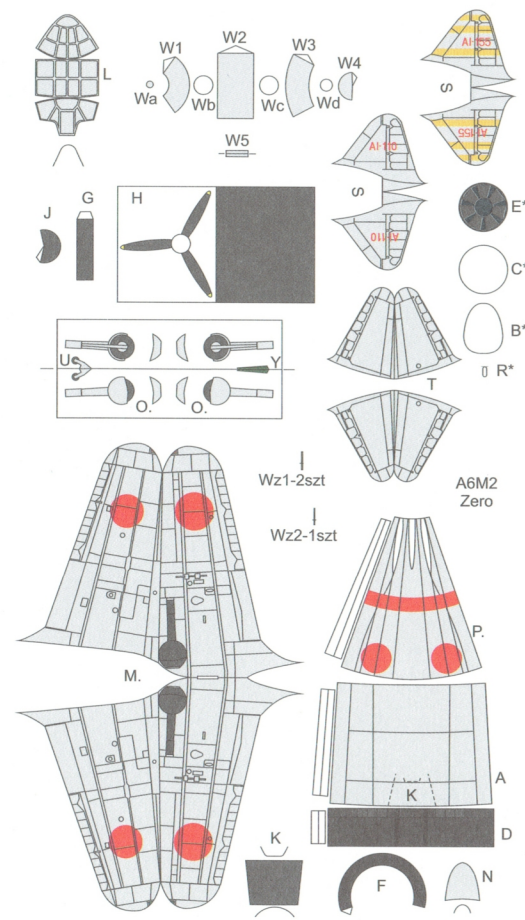
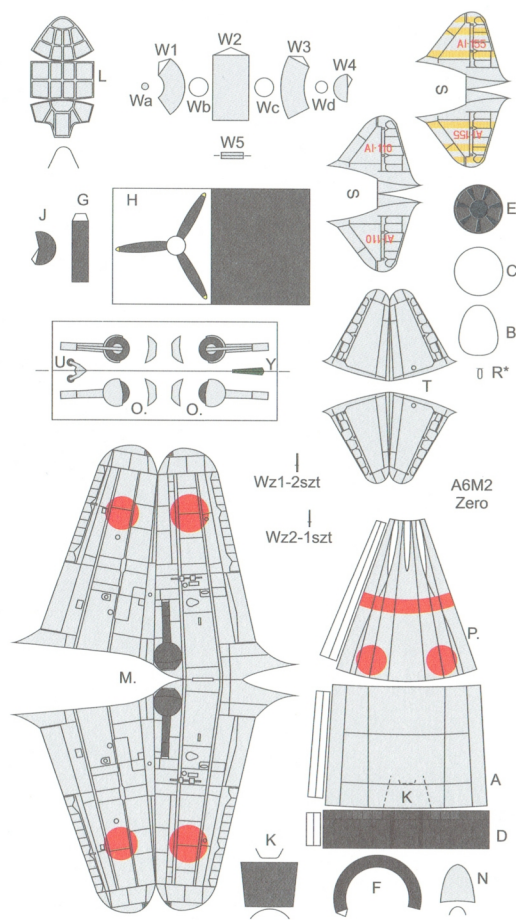

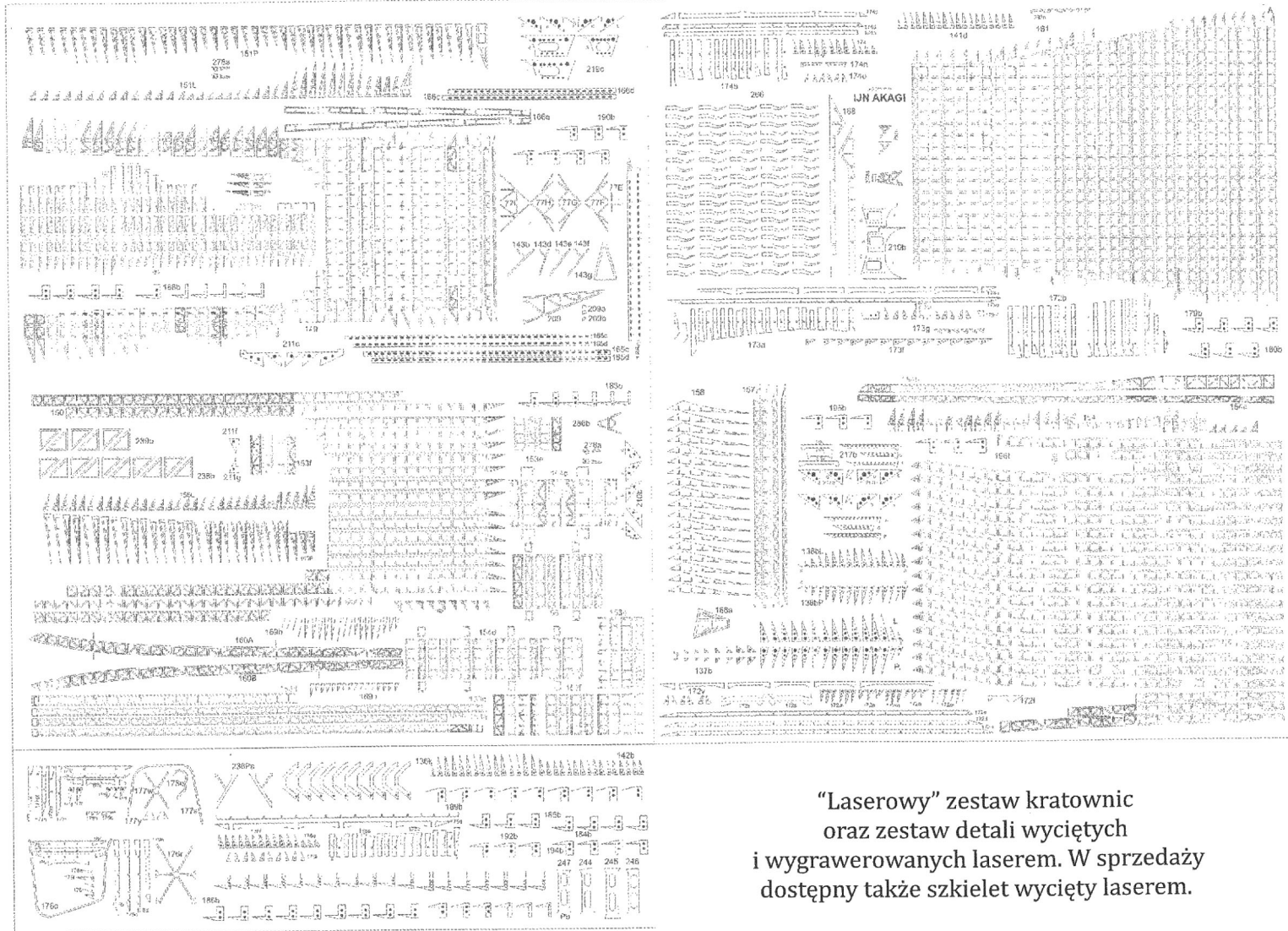
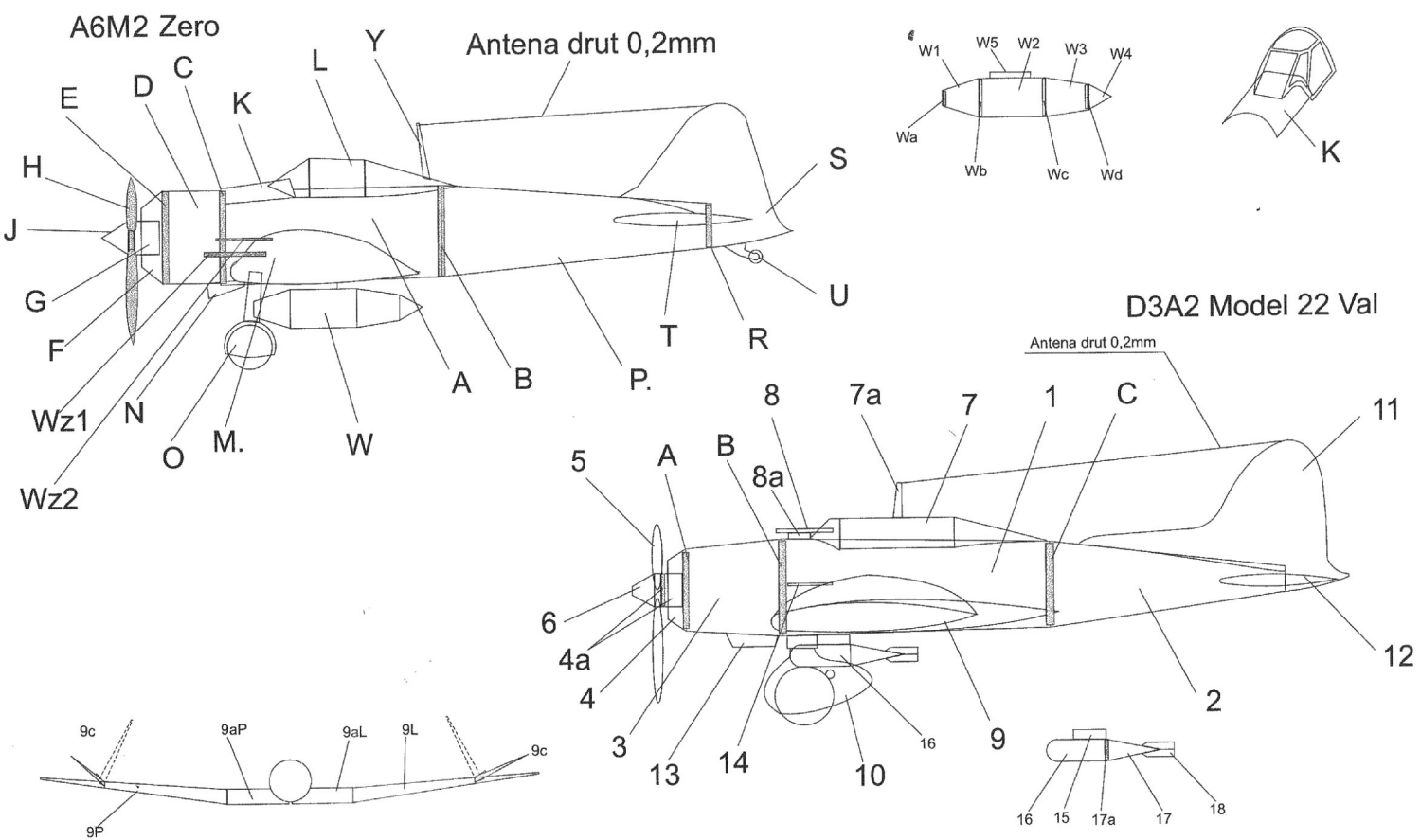
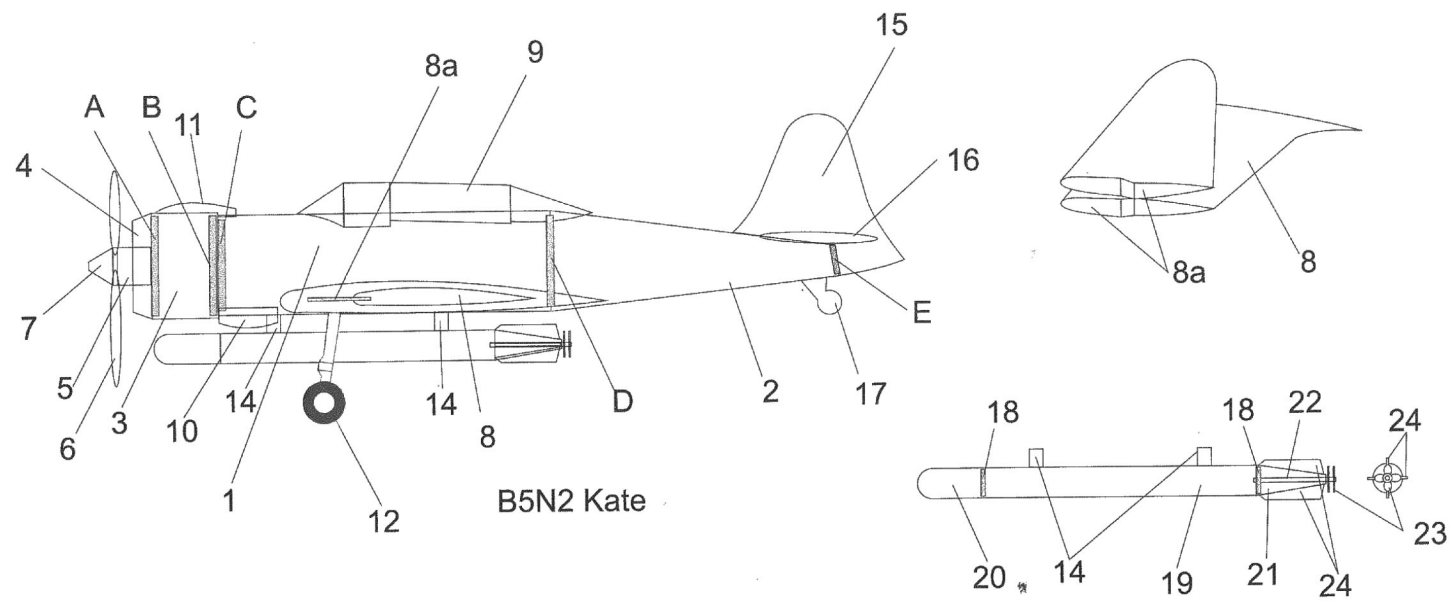

"Laserowy" zestaw kratownic oraz zestaw detali wyciętych i wygrawerowanych laserem. W sprzedaży dostępny także szkielet wycięty laserem.

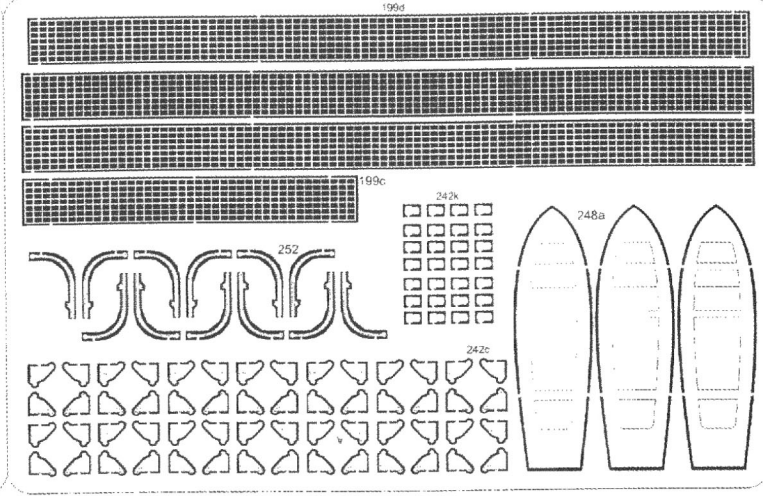
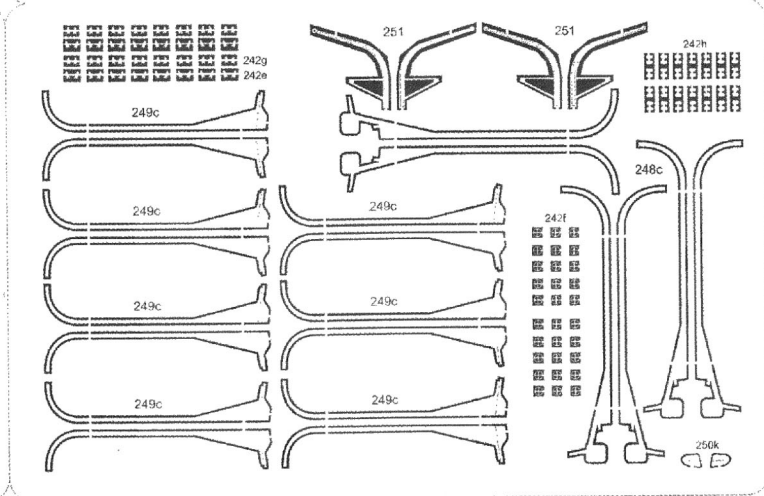
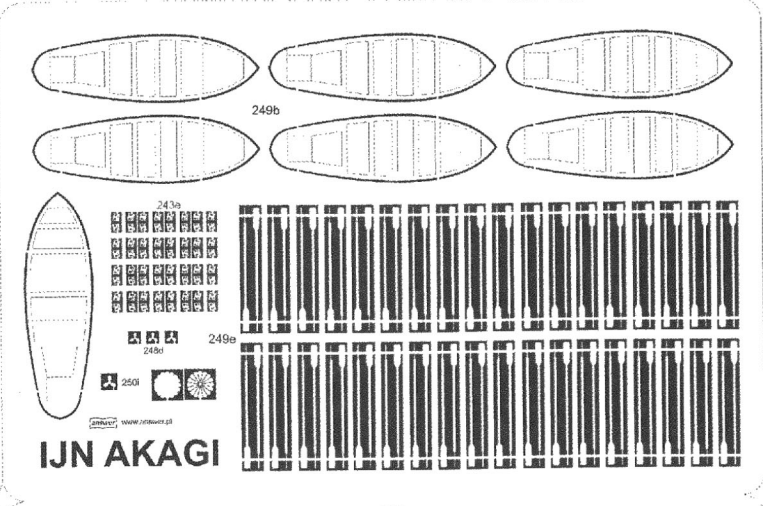
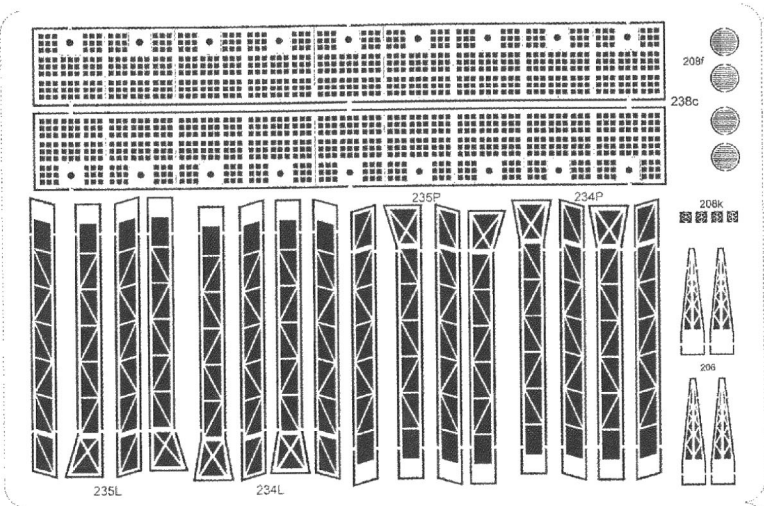
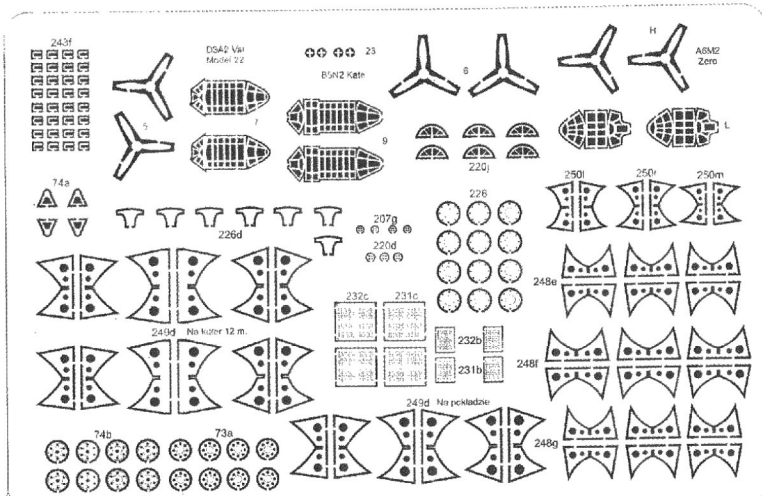
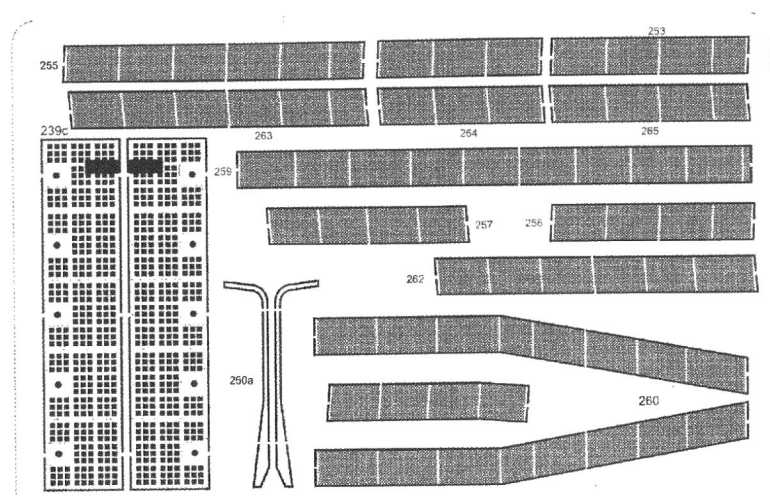

Wszystkie modele wydawnictwa Angraf
dostępne są w sprzedaży wysyłkowej!

Do wszystkich modeli dostępne są elementy
wycinane laserowo /koła, szkielety, tabliczki, itp./!



Zamówienia: tel. 0-604 250 992

e-mail: biuro@answer.pl

www.answer.pl

